

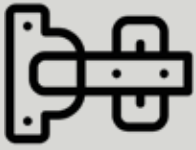

EgeTamaş

AMBALAJ ve MAKİNA SAN. TİC. A.Ş.



ÜRÜN KATALOĞU



Hakkımızda

1983 yılından bu yana **Ege Tamaş A.Ş** olarak kaliteyi müşteri odaklı bir şekilde geliştirmeyi şirket kültürünün ana ögesidir. Satış ve satış sonrası hizmetiyle müşteri memnuniyetini sağlayan firmamız, bundan sonraki süreçte de yanınızda olmayı misyon haline getirmiştir. Satış sonrası desteğini hiçbir zaman azaltmayan firmamız, sizlerle beraber sürekli büyüme politikasını sürdürecektir. Kaliteden ödün vermeyen **Ege Tamaş A.Ş.**, sektöründe öncüdür ve gelişen teknolojiyi yakından takip eder. Dürüstlük ilkimizdir. Zamanı iyi planlar, kaliteyi ön planda tutar, hızlı bir lojistik sistemi uyguluyoruz. Siz değerli iş ortaklarımız yanımızda oldukça kimliğimizden ödün vermeden emin adımlarla yolumuza devam edeceğimizi biliyoruz. Bu sepele sizlere her zaman daha iyi hizmet verebilmek adına hiç durmadan çalışıyor

ve

Mobilyada Fark Yaratıyoruz

Vizyonumuz

Türkiye'nin her yerinde yaygın, güvenilir ve aynı kalitede hizmet sunan, her kesime hitap eden, müşteri ve insan kaynağını en değerli aktifi olarak kabul eden, köklü geçmişine yakışır şekilde sürekli fark ve değer yaratan, rakiplerinin örnek aldığı, her aşamada bir tedarikçiden daha fazlasını vaad eden, evrensel, saygın ve piyasa değeri yüksek, lider bir firma olmaktır.

Misyonumuz

Çalışma ortaklarının ihtiyaç ve beklentilerini en iyi şekilde anlayarak, onlara en doğru kanaldan en uygun çözüm ve değer önerilerini sunan, yaygın satış ağı ve dağıtım kanalları ile geniş ürün ve hizmet yelpazesini en hızlı ve en etkin şekilde müşterilerine ulaştıran, etik değerlerin ve sosyal sorumluluğun bilincinde olarak müşteri memnuniyetini herşeyden üstün tutan bir firma olmaktır.



EgeTamaş

AMBALAJ ve MAKİNA SAN. TİC. A.Ş.

İÇİNDEKİLER

3-4	MENTEŞELER	KAŞIKLIKLAR	44-45
5-6	PİSTONLAR - KAPAK MEKANİZMALARI	ÇÖP KOVALARI - TEZGAH ALTI AKSESUARLAR	46-49
7-11	KAPI KOLLARI	BANYO AKSESUARLARI	50-51
12	FİTİLLER	ASKI BORULARI - RAF ALTLARI	52
13	KAPI MENTEŞELERİ	CAM VE AYNA BAĞLANTI ELEMANLARI	53-54
14	KİLİTLER	METALİ BAĞLANTI ELEMANLARI	55-56
15-20	KİMYASAL ÜRÜNLER	VOLKAN BAĞLANTI ELEMANLARI	57-71
21	MONTAJ APARATLARI	MOBİLYA VE MASA AYAKLARI	72-76
22-24	TESTERELER - MATKAP VE BİTS UÇLARI	MOBİLYA TEKERLERİ	77-78
25-34	SÜRGÜ KAPAK SİSTEM VE MEKANİZMALARI	ZIMBA TELLERİ VE ÇİVİLER	79
35-36	ALÜMİNYUM SÜRGÜ PROFİLLERİ	TAPALAR VE KEÇELER	80
37	ELKAMENT VE RİJİT PROFİLLER	RENK KARTELASI	81-82
38-40	STOR KAPAK SİSTEMLERİ	TAMAMLAYICI ÜRÜNLER	83-88
41	SÜPÜRGELİKLER	STD VİDA - DÜBEL GRUBU	89-95
42	BAZA PROFİLLERİ	EL ALETLERİ	96-100
43	ANKASTRE GRUBU	VENT KULPLAR - ASKILAR - DÜĞMELER	101-118

B2B SİSTEMİMİZ

HER ZAMAN

Yanınızda



- Ürünlerin fiyatlarına ve stok bilgilerine anlık ulaşabilir,



-Seçtiğiniz ürünleri hızlıca sipariş edebilir,



-Cari hesabınızı ve gelen faturalarınızı kontrol edebilir,



-Hesabınızla ilgili ödemeleri güvenli bir şekilde yapabilirsiniz.



Sistemimize, b2b.egetamas.com.tr adresinden veya web sitemizin ana sayfasındaki "B2B giriş" butonundan ulaşabilirsiniz.

MİNNES - NKS

KOD	ÜRÜN AÇIKLAMASI	ADET
35-30	35 mm Teleskopik Ray 300 mm	20
35-35	35 mm Teleskopik Ray 350 mm	20
35-40	35 mm Teleskopik Ray 400 mm	20
35-45	35 mm Teleskopik Ray 450 mm	20
35-50	35 mm Teleskopik Ray 500 mm	20
35-55M	35 mm Teleskopik Ray 550 mm	20



MİNNES - STD - ALRAY

KOD	ÜRÜN AÇIKLAMASI	ADET
43-30	43 mm Teleskopik Ray 300 mm	15
43-35	43 mm Teleskopik Ray 350 mm	15
43-40	43 mm Teleskopik Ray 400 mm	15
43-45	43 mm Teleskopik Ray 450 mm	15
43-50	43 mm Teleskopik Ray 500 mm	15
43-55	43 mm Teleskopik Ray 550 mm	15
43-60	43 mm Teleskopik Ray 600 mm	15
43-70	43 mm Teleskopik Ray 700 mm	15



MİNNES

KOD	ÜRÜN AÇIKLAMASI	ADET
46/30MFR	46 mm Frenli Teleskopik Ray 300 mm	12
46/35MFR	46 mm Frenli Teleskopik Ray 350 mm	12
46/40MFR	46 mm Frenli Teleskopik Ray 400 mm	12
46/45MFR	46 mm Frenli Teleskopik Ray 450 mm	12
46/50MFR	46 mm Frenli Teleskopik Ray 500 mm	12
46/55MFR	46 mm Frenli Teleskopik Ray 550 mm	12





MİNNES

KOD	ÜRÜN AÇIKLAMASI	ADET
46-30BAS	46 mm Bas-Aç Teleskopik Ray 300 mm	12
46-35BAS	46 mm Bas-Aç Teleskopik Ray 350 mm	12
46-40BAS	46 mm Bas-Aç Teleskopik Ray 400 mm	12
46-45BAS	46 mm Bas-Aç Teleskopik Ray 450 mm	12
46-50BAS	46 mm Bas-Aç Teleskopik Ray 500 mm	12



NKS - ALRAY

KOD	ÜRÜN AÇIKLAMASI	ADET
17-310	17 mm İnce Bilyalı Ray 310 mm	50
17-342	17 mm İnce Bilyalı Ray 342 mm	50
17-374	17 mm İnce Bilyalı Ray 374 mm	50
17-406	17 mm İnce Bilyalı Ray 406 mm	50
17-438	17 mm İnce Bilyalı Ray 438 mm	50



FLORE

KOD	ÜRÜN AÇIKLAMASI	ADET
ET-00550	Beyaz Çekmece Rayı 25 cm	25
ET-00551	Beyaz Çekmece Rayı 30 cm	25
ET-00552	Beyaz Çekmece Rayı 35 cm	25
ET-00553	Beyaz Çekmece Rayı 40 cm	25
ET-00554	Beyaz Çekmece Rayı 45 cm	25
ET-00555	Beyaz Çekmece Rayı 50 cm	25
ET-00556	Beyaz Çekmece Rayı 55 cm	25
ET-00557	Beyaz Çekmece Rayı 60 cm	25

KOD	ÜRÜN AÇIKLAMASI	ADET
M-D	Tas Mentеше Düz MİNNES	200
M-DB	Tas Mentеше Deve Boynu MİNNES	200
M-SDB	Tas Mentеше Süper Deve Boynu MİNNES	200
934055800	Tas Mentеше Düz STD	250
976707800	Tas Mentеше Deve Boynu STD	250
976708800	Tas Mentеше Süper Deve Boynu STD	250



KOD	ÜRÜN AÇIKLAMASI	ADET
ET-06753	Hidrolik Mentеше Düz MİNNES	100
ET-06754	Hidrolik Mentеше Deve Boynu MİNNES	100
ET-06755	Hidrolik Mentеше Süper Boynu MİNNES	100
ET-04796	Hidrolik Mentеше Düz STD	100
ET-04797	Hidrolik Mentеше Deve Boynu STD	100
ET-04798	Hidrolik Mentеше Süper Deve Boynu STD	100



MİNNES

KOD	ÜRÜN AÇIKLAMASI	ADET
ET-06753-1	3D Tabanlı Hidrolik Mentеше Düz	100
ET-06754-1	3D Tabanlı Hidrolik Mentеше Deve Boynu	100





KOD	ÜRÜN AÇIKLAMASI	ADET
936930800	45 Derece Menteşe	200
936931800	90 Derece Menteşe	200
936932800	135 Derece Menteşe	100
936933800	165 Derece Menteşe	100



KOD	ÜRÜN AÇIKLAMASI	ADET
ET-06465	45 Derece Hidrolik Menteşe	200
ET-06466	90 Derece Hidrolik Menteşe	200
ET-06481	165 Derece Hidrolik Menteşe	100



MİNNES

KOD	ÜRÜN AÇIKLAMASI	ADET
M-3D	3D Tabanlı Menteşe Düz	200
M-3DSB	3D Tabanlı Menteşe Deve Boynu	200

STD

KOD	ÜRÜN AÇIKLAMASI	ADET
36160	Gazlı Piston 80 Newton	100
36161	Gazlı Piston 100 Newton	100
ET-28350	Gazlı Piston 120 Newton	100
928830800	Kısa Gazlı Piston 60 Newton	100
ET-28831	Kısa Gazlı Piston 80 Newton	100
ET-54380	Kısa Gazlı Piston 100 Newton	100
ET-06769	Gazlı Piston 80 Newton Mini 19 cm	100



STD

KOD	ÜRÜN AÇIKLAMASI	ADET
59046	Yavaş Kapanan Gazlı Piston 80 Newton	100
59047	Yavaş Kapanan Gazlı Piston 100 Newton	100



STD

KOD	ÜRÜN AÇIKLAMASI	ADET
58039	Beyaz Gazlı Piston 80 Newton	100
ET-58040	Beyaz Gazlı Piston 100 Newton	100





MEKAR

KOD	ÜRÜN AÇIKLAMASI	ADET
ET-06225	Kalkar Kapak Mekanizması AYARLI 41500	1



MEKAR

KOD	ÜRÜN AÇIKLAMASI	ADET
ET-06019	Metal Lale Makas	10



MEKAR

KOD	ÜRÜN AÇIKLAMASI	ADET
ET-05438	Plastik Lale Makas Şeffaf	10



MEKAR

KOD	ÜRÜN AÇIKLAMASI	ADET
ET-00830/1	Bar Makası Beyaz	50
ET-00832	Bar Makası Kahve	50

YÜKSEL

KOD	ÜRÜN AÇIKLAMASI	ADET
90121180	Beta Rozetli Kapı Kolu	1 Tk
	Krom - Siyah - Antrasit - İnox - Kapuçino	

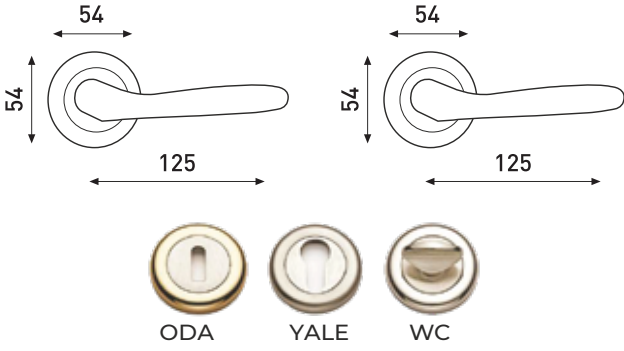

YÜKSEL

KOD	ÜRÜN AÇIKLAMASI	ADET
90221180	Delta Rozetli Kapı Kolu	1 Tk
	Krom - Siyah - Antrasit - İnox - Kapuçino	

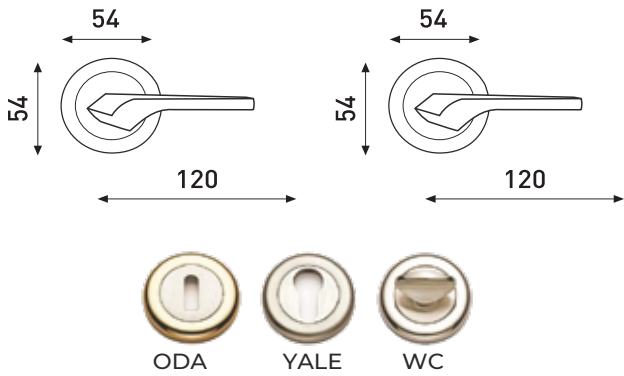



YÜKSEL

KOD	ÜRÜN AÇIKLAMASI	ADET
90021180	Alfa Rozetli Kapı Kolu	1Tk
	Krom - Siyah - Antrasit - İnox - Kapuçino	

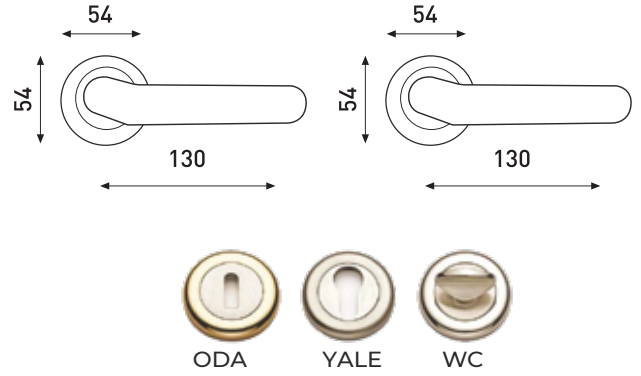

YÜKSEL

KOD	ÜRÜN AÇIKLAMASI	ADET
89921180	Gama Rozetli Kapı Kolu	1Tk
	Krom - Siyah - Antrasit - İnox - Kapuçino	

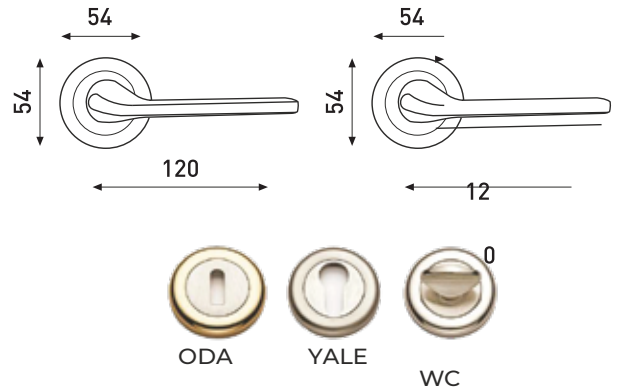

YÜKSEL

KOD	ÜRÜN AÇIKLAMASI	ADET
89323	Tesla İtalyan Rozetli Kapı Kolu	1 Tk
	Krom - Siyah - Antrasit - İnox - Kapuçino	



YÜKSEL

KOD	ÜRÜN AÇIKLAMASI	ADET
88722	Labella Rozetli Kapı Kolu	1 Tk
	Krom - Siyah - Antrasit - İnox - Kapuçino	



YÜKSEL

KOD	ÜRÜN AÇIKLAMASI	ADET
88923	Auris Rozetli Kapı Kolu	1 Tk
	Krom - Siyah - Antrasit - İnox - Kapuçino	



YÜKSEL

KOD	ÜRÜN AÇIKLAMASI	ADET
89222	Verona Rozetli Kapı Kolu	1 Tk
	Krom - Siyah - Antrasit - İnox - Kapuçino	





YÜKSEL

KOD	ÜRÜN AÇIKLAMASI	ADET
45321	Paslanmaz Kol Rozetli Mars	1Tk
45121	Paslanmaz Kol Rozetli Hastane	1Tk

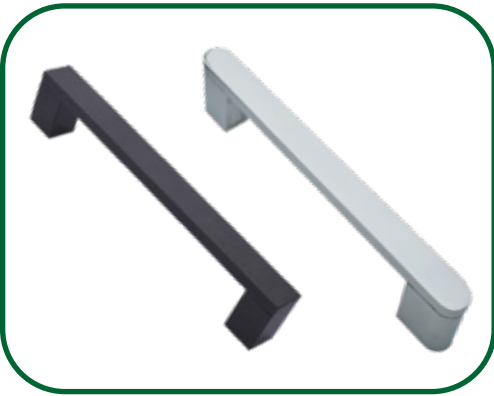

YÜKSEL

KOD	ÜRÜN AÇIKLAMASI	ADET
2220	Çekme Kol İtalyan Kare 25-30-35-40 cm	1Tk
2221	Çekme Kol İtalyan Oval 25-30-35-40 cm	1Tk

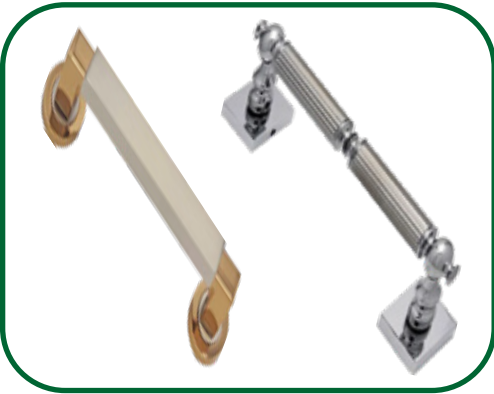

YÜKSEL

KOD	ÜRÜN AÇIKLAMASI	ADET
Y-880	Çekme Kol Kare 25-30-35-40 cm	1Tk
Y-882	Çekme Kol Dragon 25-30-35-40 cm	1Tk



YÜKSEL

KOD	ÜRÜN AÇIKLAMASI	ADET
Y-955	Çelik Tokmak Elmas	1Tk
Y-953	Çelik Tokmak Kumru	1Tk

DİKO

KOD	ÜRÜN AÇIKLAMASI	ADET
DK-1222-4	1222 Rozetli Kapı Kolu Saten Oda	1 Tk
DK-1222-6	1222 Aynalı Kapı Kolu Saten Oda	1 Tk



DİKO

KOD	ÜRÜN AÇIKLAMASI	ADET
DK-1219	1171 Rozetli Kapı Kolu Saten Oda	1 Tk
DK-1219-8	1171 Aynalı Kapı Kolu Saten Oda	1 Tk



DİKO

KOD	ÜRÜN AÇIKLAMASI	ADET
DK-1124	1124 Rozetli Kapı Kolu Saten Oda	1 Tk
DK-1124-10	1124 Aynalı Kapı Kolu Saten Oda	1 Tk



DİKO

KOD	ÜRÜN AÇIKLAMASI	ADET
DK-1237-6	1237 Rozetli Kapı Kolu Saten Oda	1 Tk
DK-1237-2	1237 Aynalı Kapı Kolu Saten Oda	1 Tk



TUNA

KOD	ÜRÜN AÇIKLAMASI	ADET
TF-008	Kapı Fitili Yan D 8 mm - 10 mm - 12 mm	100
Beyaz - Şeffaf - Siyah - Kahverengi - Krem - Gri - Antrasit		

TUNA

KOD	ÜRÜN AÇIKLAMASI	ADET
TF-016	Kapı Fitili Orta D 8 mm - 10 mm - 12 mm	100
Beyaz - Şeffaf - Siyah - Kahverengi - Krem - Gri - Antrasit		

TUNA

KOD	ÜRÜN AÇIKLAMASI	ADET
TF-1039	Kapı Fitili Çatı Yan Çift Kulak 10 mm - 11 mm - 12 mm	100
Beyaz - Şeffaf - Siyah - Kahverengi - Krem - Gri - Antrasit		

TUNA

KOD	ÜRÜN AÇIKLAMASI	ADET
TF-1014	Kapı Fitili Çatı Yan Tek Kulak 10 mm - 11 mm - 12 mm	100
Beyaz - Şeffaf - Siyah - Kahverengi - Krem - Gri - Antrasit		

BAYRAKTAR

KOD	ÜRÜN AÇIKLAMASI	ADET
ET-06054	10 cm Alüminyum Mentеше Cumbalı Sağ	150
ET-06054/1	10 cm Alüminyum Mentеше Cumbalı Sol	150



KOD	ÜRÜN AÇIKLAMASI	ADET
ET-06557	10 cm Saç Kelebek Mentеше Saten	240
ET-06557/1	10 cm Saç Kelebek Mentеше Siyah	240
ET-06703	10 cm Saç Kelebek Mentеше Saten YÜKSEL	240
ET-06704	10 cm Saç Kelebek Mentеше Siyah YÜKSEL	240



KOD	ÜRÜN AÇIKLAMASI	ADET
ET-06293	10 cm Çelik Yönsüz Mentеше Saten	240
ET-06293-1	12 cm Çelik Yönsüz Mentеше Siyah	240
ET-06701	12 cm Çelik Yönsüz Mentеше Saten YÜKSEL	200
ET-06702	12 cm Çelik Yönsüz Mentеше Siyah YÜKSEL	200



MADE

KOD	ÜRÜN AÇIKLAMASI	ADET
ET-04641	Kapı Tamponu Saç Krom	50
4104-01	Kapı Stoperi Yere Monte Uzun	60
4105-01	Kapı Stoperi Yere Monte Kısa	60
00250	Kapı Stoperi 8 Şeffaf	250





METLOX

KOD	ÜRÜN AÇIKLAMASI	ADET
ET-06566	40 mm Düz Sessiz Kilit Oda	40
ET-06567	40 mm Düz Sessiz Kilit Wc	40
ET-06515	40 mm Oval Sessiz Kilit Oda	40
ET-06516	40 mm Oval Sessiz Kilit Wc	40
ET-06501	45 mm Sessiz Kilit Oda	40
ET-06502	45 mm Sessiz Kilit Wc	40

METLOX

KOD	ÜRÜN AÇIKLAMASI	ADET
ET-06267/1	40 mm Düz Rulmanlı Kilit Oda	40
ET-06268/1	40 mm Düz Rulmanlı Kilit Wc	40
ET-06267	40 mm Oval Rulmanlı Kilit Oda	40
ET-06268	40 mm Oval Rulmanlı Kilit Wc	40

KOD	ÜRÜN AÇIKLAMASI	ADET
ET-01604	Topuzlu Kilit Paslanmaz Saten Oda	40
ET-05313	Topuzlu Kilit Paslanmaz Saten Wc	40

STD

KOD	ÜRÜN AÇIKLAMASI	ADET
ET-05220	Çekmece Kilidi Kare Kıрма Anahtarlı STD	240
926578800	Çekmece Kilidi Oval STD	240

MADWOLF

KOD	ÜRÜN AÇIKLAMASI	ADET
ET-03845	İskelet Tutkal 500 Gr	40
ET-03844	İskelet Tutkal 3 Kg	8
ET-04318	İskelet Tutkal 8 Kg	1
ET-04317	İskelet Tutkal 18 Kg	1
ET-06320	İskelet Tutkal 50 Kg	1



INTERBOND

KOD	ÜRÜN AÇIKLAMASI	ADET
7005	İskelet Tutkalı 600 Gr	24
7109	İskelet Tutkalı 3 Kg	8
7103	İskelet Tutkalı 10 Kg	1
7104	İskelet Tutkalı 25 Kg	1



KOD	ÜRÜN AÇIKLAMASI	ADET
ET-03843	Boncuk Tutkal 319 MADWOLF	25 Kg
ET-06393	Boncuk Tutkal NB45	25 Kg
ET-06671	Boncuk Tutkal İnterbond	25 Kg



SOMAFIX

KOD	ÜRÜN AÇIKLAMASI	ADET
S604	Deniz Tutkalı 550 Gr Şeffaf	24
S605	Deniz Tutkalı 550 Gr Beyaz	24





TYTAN

KOD	ÜRÜN AÇIKLAMASI	ADET
10049290	Hızlı Yapıştırıcı Büyük	24
10049289	Hızlı Yapıştırıcı Küçük	24



TYTAN

KOD	ÜRÜN AÇIKLAMASI	ADET
ET-06858	Pipetli Pu Köpük 600 Gr	12
ET-04920	Pipetli Pu Köpük 750 MI	12



TYTAN

KOD	ÜRÜN AÇIKLAMASI	ADET
ET-05000	Akrilik Silikonize Mastik 500 Gr Beyaz	24
	A.Meşe - Krem - Gri -Siyah - Bronz - Kahve	



TYTAN

KOD	ÜRÜN AÇIKLAMASI	ADET
ET-05465	Silikon 280 Gr Şeffaf	24
ET-05465	Silikon 280 Gr Beyaz	24

TYTAN

KOD	ÜRÜN AÇIKLAMASI	ADET
ET-06500	60 Saniye Pipetli Pu Köpük 750 Ml	12
ET-06500-1	60 Saniye Tabanlı Pu Köpük 750 Ml	12
ET-06500-2	60 Saniye Pipetli Pu Köpük 300 Ml	12



TYTAN

KOD	ÜRÜN AÇIKLAMASI	ADET
ET-05019	Lexy 60 Pu Köpük 750 Ml	12
10052090	Lexy 20 Pu Köpük 300 Ml	12



TYTAN

KOD	ÜRÜN AÇIKLAMASI	ADET
ET-02085	Ultra Fast 70 Tabanlı PU Köpük	12
10052281	Ultra Fast 50 Pipetli PU Köpük	12



TYTAN

KOD	ÜRÜN AÇIKLAMASI	ADET
ET-04919-1	Çelik Kapı Montaj Köpüğü Pipetli 750 Ml	12
10051840	B1 Yangın Köpüğü Pipetli 750 Ml	12





TYTAN

KOD	ÜRÜN AÇIKLAMASI	ADET
10052220	Eurowindow Mastik 310 MI Beyaz	24
ET-06724	Duşakabin Silikonu 280 MI Şeffaf & Beyaz	24



TYTAN

KOD	ÜRÜN AÇIKLAMASI	ADET
ET-06726	Anti Kuf Nötr Silikon 280 MI Şeffaf	24
10051172	Akvaryum Silikonu 280 MI Şeffaf	24



TYTAN

KOD	ÜRÜN AÇIKLAMASI	ADET
ET-06140	Ayna Silikonu 280 MI	24
ET-02090	Nötr Dış Cephe Silikonu 280 MI	24



TYTAN

KOD	ÜRÜN AÇIKLAMASI	ADET
ET-02092	Sıvı Çivi 300 MI	12
ET-02091	1000 Fix Akrilik Montaj Yapıştırıcı 310 MI	24

TYTAN

KOD	ÜRÜN AÇIKLAMASI	ADET
10049630	Fast Fix Montaj Yapıştırıcı 290 Ml	12
10053674	Fix Up High Tack Montaj Yapıştırıcı 290 Ml	12



TYTAN

KOD	ÜRÜN AÇIKLAMASI	ADET
ET-02094	Fix 2 Ultra Şeffaf Montaj Yapıştırıcı 290 Ml	12
ET-02093	Fix 2 Turbo Gt Montaj Yapıştırıcı 290 Ml	12



STD

KOD	ÜRÜN AÇIKLAMASI	ADET
ET-05506	Silikon Tabancası Plastik	48
961507800	Silikon Tabancası Metal	25



TYTAN

KOD	ÜRÜN AÇIKLAMASI	ADET
ET-04937	Köpük Tabancası Metal	1
10042129	Köpük Tabancası Plastik	1





Üniversal Renkler



SARI
RAL 1018

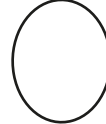

BEYAZ
RAL 9003



SİYAH
RAL 9005



MAVİ
RAL 5010



GİRİ
RAL 7015

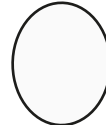

MAT BEYAZ
RAL 9003 M



KIRMIZI
RAL 3020



MAT SİYAH
RAL 9004



YEŞİL
RAL 6018



ANTRASİT
RAL 7031

Fosforlu Renkler



FOSFORLU
SARI



FOSFORLU
YEŞİL



FOSFORLU
TURUNCU

Metalik Renkler



METALİK GİRİ
RAL 9006

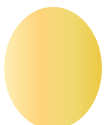

ALTIN
RAL 270

KOD	ÜRÜN AÇIKLAMASI	ADET
ART	TYTAN Sprey Boya Çeşitli Renkler	12



HANDS

KOD	ÜRÜN AÇIKLAMASI	ADET
45500-1	Dolap Montaj Aparatı 46*72 cm	5
45500-2	Dolap Montaj Aparatı 130*180 cm	5
45500-3	Dolap Montaj Aparatı 160*270 cm	5



HANDS

KOD	ÜRÜN AÇIKLAMASI	ADET
49000-1	Köşe Birleştirme Aparatı Açık	1
49000-2	Köşe Birleştirme Aparatı Kapalı	1

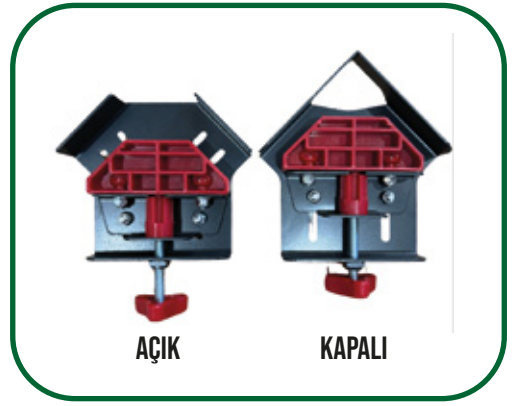

HANDS

KOD	ÜRÜN AÇIKLAMASI	ADET
47000	Çekmece Yüzü Montaj Aparatı	1



HANDS

KOD	ÜRÜN AÇIKLAMASI	ADET
48000	Tas Menteşe Yuvası Delme Aparatı	1



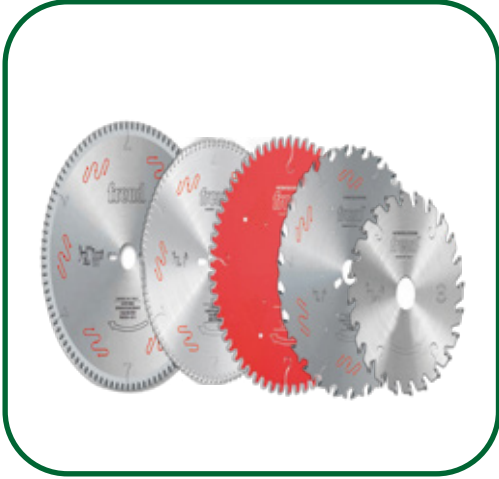

FREUD

KOD	ÜRÜN AÇIKLAMASI	ADET
LU3D0600	300x96 Sunta & Laminant Testere	1
LU3D0400	250x80 Sunta & Laminant Testere	1
LU3A0200	250x80 Sessiz Sivri Diş Testere	1
LU3A0300	300x96 Sessiz Sivri Diş Testere	1
LU1C0100	250x22 Ahşap Sağ & Sol Diş Testere	1
LU1C0400	300x26 Ahşap Sağ & Sol Diş Testere	1
LU5B0201	250x80 Alüminyum Testere	1
LU5B0801	300x96 Alüminyum Testere	1
ET-00401	125x12 Elmas Çiftli Çizici	1
ET-00468	125x24 Elmas Tekli Çizici	1

TATU

KOD	ÜRÜN AÇIKLAMASI	ADET
ET-03413	Çivi Tabancası F-32	1
ET-05368	Çivi Tabancası F-50	1
ET-05357	Zimba Tabancası	1

Kapı Fitili Çatı Yan Çift Kulak 10 mm - 11 mm - 12 mm

KOD	ÜRÜN AÇIKLAMASI	ADET
ET-05291	Temizleme Bıçağı Rulmanlı	5
ET-04206	Temizleme Bıçağı Rulmansız	5
ET-05290	Stand Kanal Açma Bıçağı	1

KOD	ÜRÜN AÇIKLAMASI	ADET
ET-02066	Havşa Uç 3 mm	5
ET-02072	Havşa Uç 3,5 mm	5
ET-05172	Menteşe Matkabı 18mm	5
ET-05102	Menteşe Matkabı 20 mm	5
ET-03812	Menteşe Matkabı 22 mm	5
ET-05926	Menteşe Matkabı 25 mm	5
ET-280	Menteşe Matkabı 35 mm	5



KOD	ÜRÜN AÇIKLAMASI	ADET
HSS-2	HSS Matkap Ucu 2 mm	100
HSS-2,5	HSS Matkap Ucu 2,5 mm	100
HSS-3	HSS Matkap Ucu 3 mm	100
HSS-3,5	HSS Matkap Ucu 3,5 mm	100
HSS-4	HSS Matkap Ucu 4 mm	100
HSS-4,5	HSS Matkap Ucu 4,5 mm	100
HSS-5	HSS Matkap Ucu 5 mm	100
HSS-6	HSS Matkap Ucu 6 mm	50
HSS-7	HSS Matkap Ucu 7 mm	50
HSS-8	HSS Matkap Ucu 8 mm	50
HSS-9	HSS Matkap Ucu 9 mm	50
HSS-10	HSS Matkap Ucu 10 mm	50



KOD	ÜRÜN AÇIKLAMASI	ADET
T111C	Dekubaj Bıçağı	50
ET-05287	Jilet Bıçak 50mm	10
ET-05288	Jilet Bıçak 60mm	10





KOD	ÜRÜN AÇIKLAMASI	ADET
PZ2-25	Bits Uç PZ 25 mm	25
PZ2-50	Bits Uç PZ 50 mm	30
PZ2-75	Bits Uç PZ 75 mm	35
PZ2-100	Bits Uç PZ 100 mm	10
PZ2-150	Bits Uç PZ 150 mm	10



KOD	ÜRÜN AÇIKLAMASI	ADET
PH2-25	Bits Uç PH 25 mm	25
PH2-50	Bits Uç PH 50 mm	30
PH2-75	Bits Uç PH 75 mm	35
PH2-100	Bits Uç PH 100 mm	10
PH2-150	Bits Uç PH 150 mm	10



KOD	ÜRÜN AÇIKLAMASI	ADET
933527800	Bits Uç T 30x50 Torx	30
933528800	Bits Uç T 30x75 Torx	30



KOD	ÜRÜN AÇIKLAMASI	ADET
ET-005534	Manyetik Uzatma Adaptörü 60 mm	20



LC100 ÇİFT YAVAŞLATICI

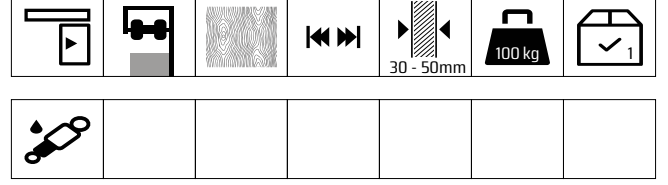

1 Set İçeriği |

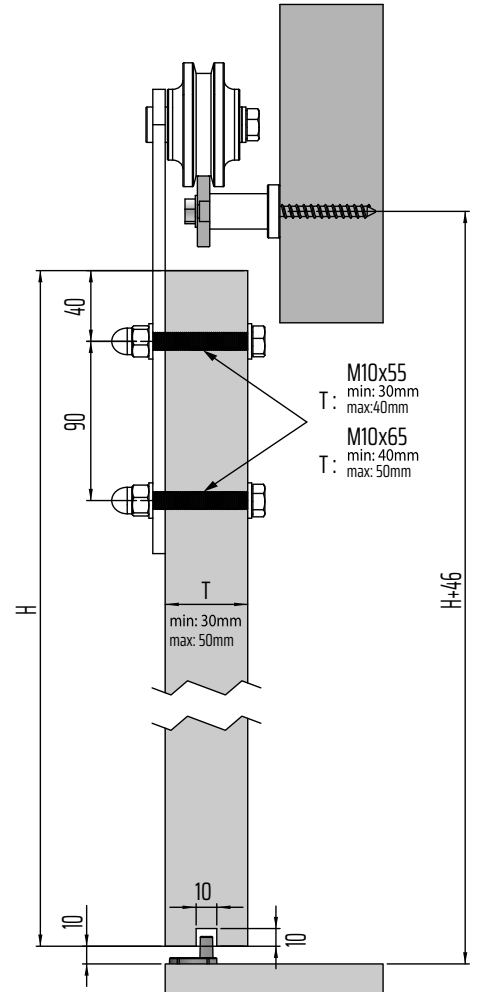

Kod	T (mm)	Kutu	Volume (m ³)	Ağırlık (kg)	Birim
L-2131	30-50	1	0,0162	7,6	1Tk - 1Kapı



1 Set İçeriği

LC58

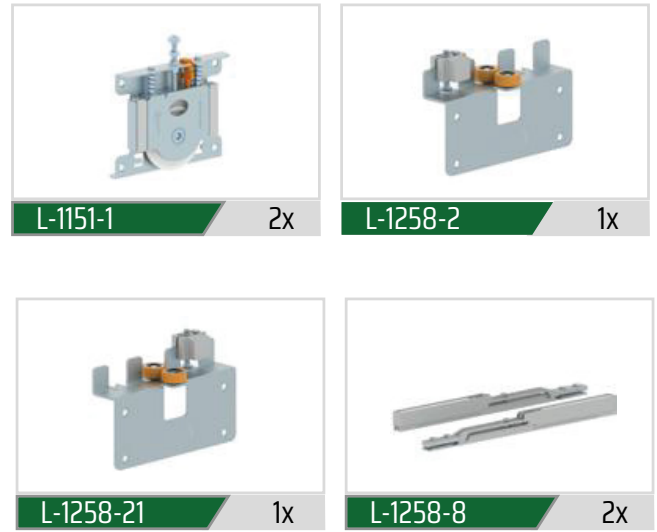

Kod	T (mm)	Box	Volume (m ³)	Ağırlık (kg)	Birim
L-1258	18-22	18	0,035	16,2	1Tk - 1Kapak

Technical Drawing	Code	T (mt)	Bağ Band	Volume (m ³)	Weight (kg)	Unit
<p>Alüminyum Üst Ray</p>	L-3174-1	2.00	6	0,0208	1,588	Adet Pcs
	L-3174-2	2.50		0,0260	1,985	
	L-3174-3	3.00		0,0312	2,382	
<p>Alüminyum Alt Ray</p>	L-3143-1	2.00	20	0,011	0,5700	Adet Pcs
	L-3143-2	2.50		0,03	0,7125	
	L-3143-3	3.00		0,036	0,8	
<p>Alüminyum Alt Ray Kapak Profili /</p>	L-3144-1	2.00	40	0,0042	0,1180	Adet Pcs
	L-3144-2	2.50		0,00525	0,1475	
	L-3144-3	3.00		0,0063	0,1770	

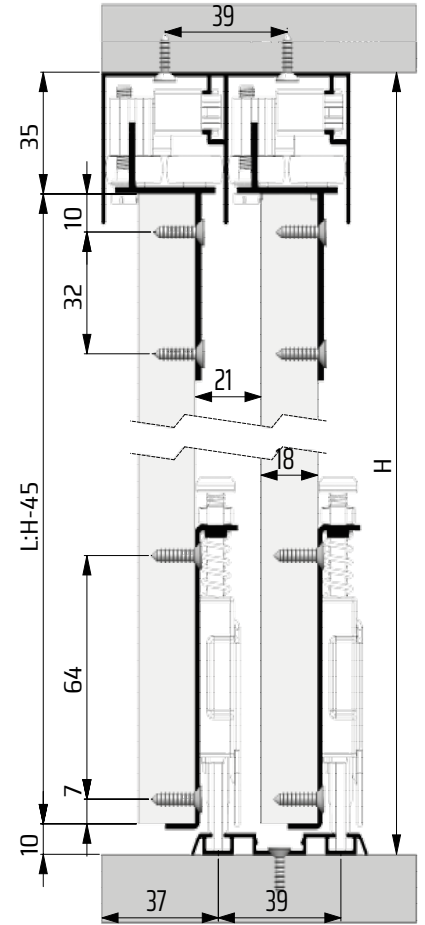



1 Set İçeriği

LC60



Kod	T (mm)	Koli	Volume (m³)	Ağırlık (kg)	Birim
L-1141	18-22	72	0,027	17,6	1Tk - 1Kapak

Teknik Çizim	Kod	T (mm)	Bağ Band	Volume (m³)	Ağırlık (kg)	Adet
<p>PVC Üst Ray</p>	L-3703	3.00	50	0,0225	0,200	Adet
<p>PVC Alt Ray</p>	L-3701	3.00	50	0,03375	0,165	Adet
<p>Alüminyum Alt Ray</p>	L-3106	3.00	50	0,022	0,300	Adet

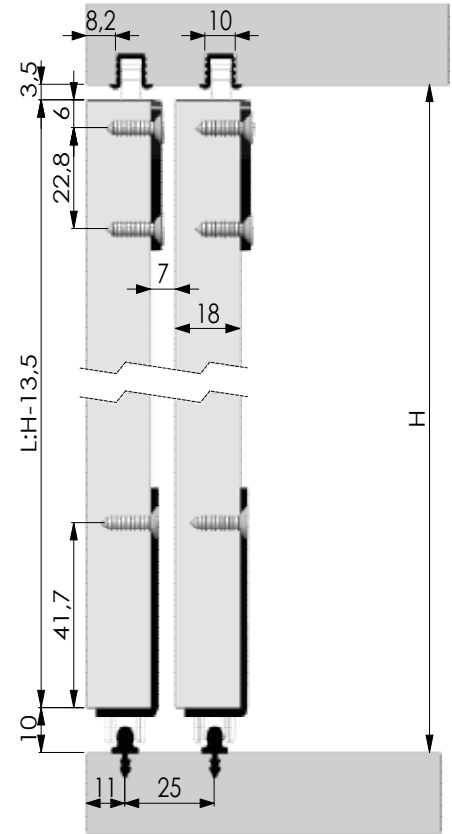



1 Set İçeriği

LC75 AY-SC



L-1155	T (mm)	Koli	Volume (m ³)	Ağırlık (kg)	Birim /
L-1155	18-22	18	0,035	15,2	1 Tk - 1 Kapak

Teknik Açıklama	Kod	T (mt)	Bağ Band	Volume (m ³)	Ağırlık (kg)	Adet
<p>Alüminyum Üst Ray</p>	L-3145-1	2.00	6	0,0208	1,4860	Adet
	L-3145-2	2.50		0,026	1,8575	
	L-3145-3	3.00		0,0432	2,235	
<p>Alüminyum Alt Ray</p>	L-3143-1	2.00	20	0,011	0,5700	Adet
	L-3143-2	2.50		0,03	0,7125	
	L-3143-3	3.00		0,036	0,800	
<p>Alüminyum Alt Ray Kapak Profili</p>	L-3144-1	2.00	40	0,0042	0,1180	Adet
	L-3144-2	2.50		0,00525	0,1475	

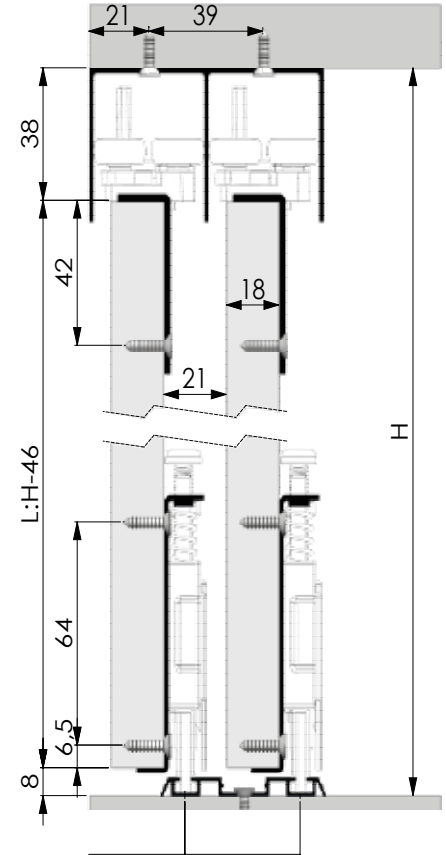



1 Set İçeriği

LC30



Kod	T (mm)	Koli	Volume (m³)	Ağırlık (kg)	Birim /
L-1121	18-22	72	0,027	7,86	1Tk - 1Kapak

Teknik Çizim	Kod	T (mt)	Bağ Band	Volume (m³)	Ağırlık (kg)	
<p>PVC Üst Ray</p>	L-3703	3.00	50	0,0225	0,200	Adet
<p>PVC Alt Ray</p>	L-3701	3.00	50	0,03375	0,165	Adet
<p>Alüminyum Alt Ray</p>	L-3106	3.00	50	0,3375	0,300	Adet

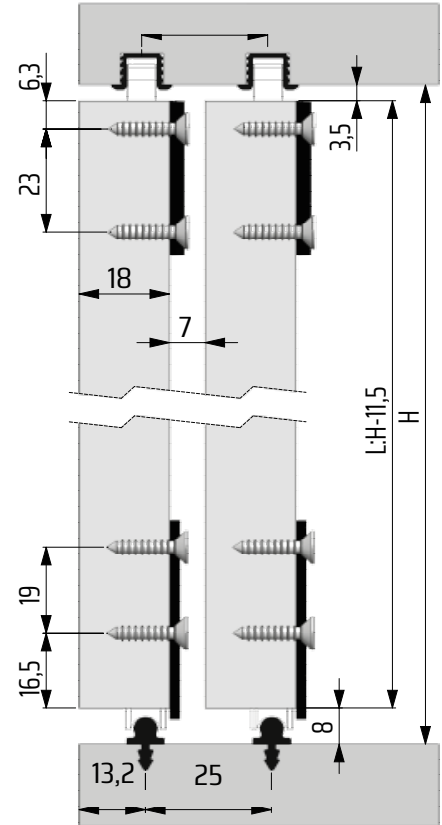



1 Set İçeriği |

LC75 AY-UK

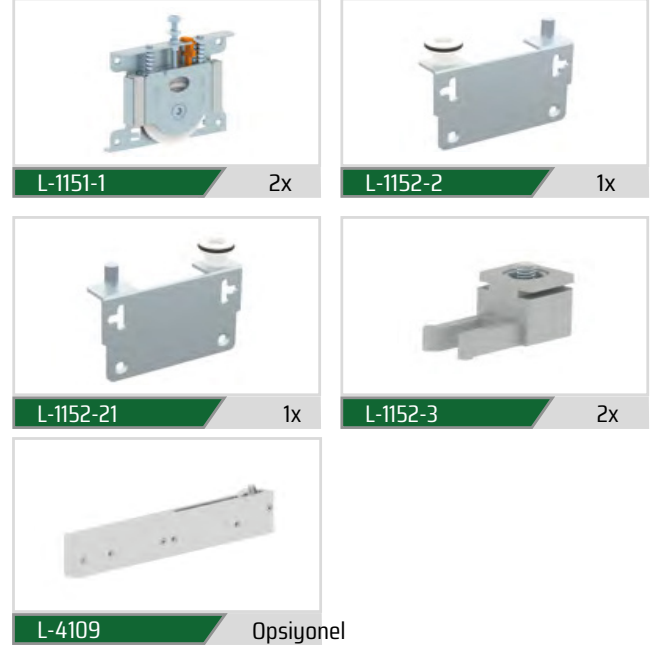

Kod	T (mm)	Koli	Volume (m ³)	Ağırlık (kg)	Birim
L-1152	18-22	42	0,035	28,56	1Tk - 1 Kapak

Teknik Çizim	Kod	T (mm)	Bağ Band	Volume (m ³)	Ağırlık (kg)	Adet
<p>Alt-Üst Ray</p>	L-3142-1	2.00	20	0,0096	0,4160	Adet
	L-3142-2	2.50		0,012	0,5200	
	L-3142-3	3.00		0,0144	0,6240	
<p>Üst Ray</p>	L-3123-1	2.00	10	0,015	0,9140	Adet
	L-3123-2	2.50		0,019	1,1425	
	L-3123-3	3.00		0,023	1,3710	
<p>Tekli Alt-Üst Ray</p>	L-3124	3.00	20	0,015	0,6240	Adet
	L-3124-2	2.50		0,0125	0,520	
<p>Alt Ray PVC</p>	L-3703	3.00	50	0,0225	0,200	Adet

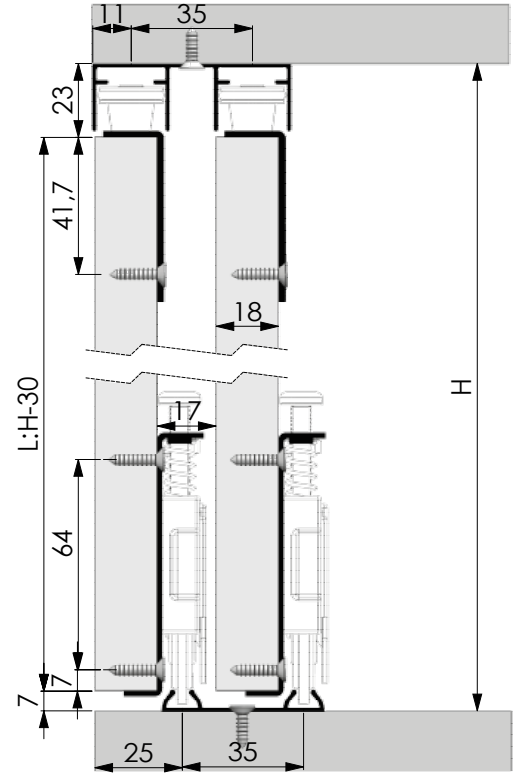



1 Set İçeriği |

LC80 AY



Kod	T (mm)	Koli	Volume (m ³)	Ağırlık (kg)	Birim /
L-1191	18-22	56	0,035	29,5	1Tk-1Kapak

Teknik Çizim	Kod	T (mm)	Bağ Band	Volume (m ³)	Ağırlık (kg)	Adet
<p>Alüminyum Üst Ray</p>	L-3123-1	2.00	10	0,015	0,9140	Adet
	L-3123-2	2.50		0,019	1,1425	
	L-3123-3	3.00		0,023	1,3710	
<p>Alüminyum Tekli Alt-Üst Ray</p>	L-3124	3.00	10	0,015	0,6240	Adet
	L-3124-2	2.50		0,0125	0,520	
<p>Alüminyum Alt Ray</p>	L-3125-1	2.00	20	0,013	0,5260	Adet
	L-3125-2	2.50		0,01625	0,6575	
	L-3125-3	3.00		0,0195	0,7890	
<p>Alüminyum Alt-Üst Ray</p>	L-3106	3.00	20	0,03375	0,300	Adet

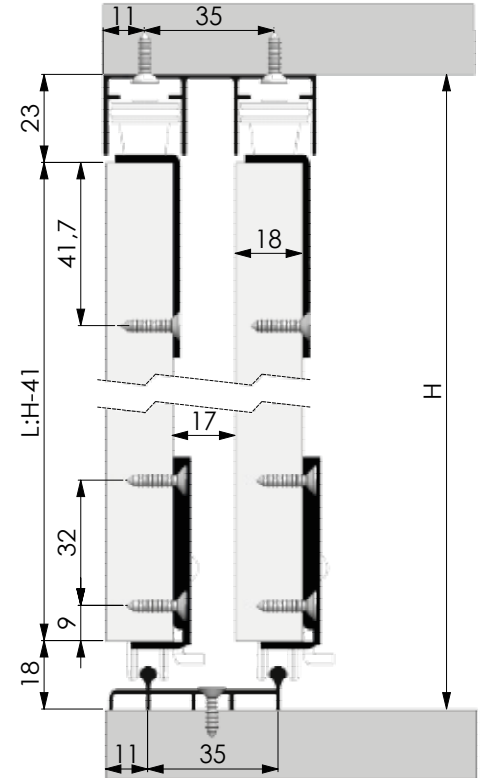



1 Set İçeriği |

LC65 Üstten Montaj

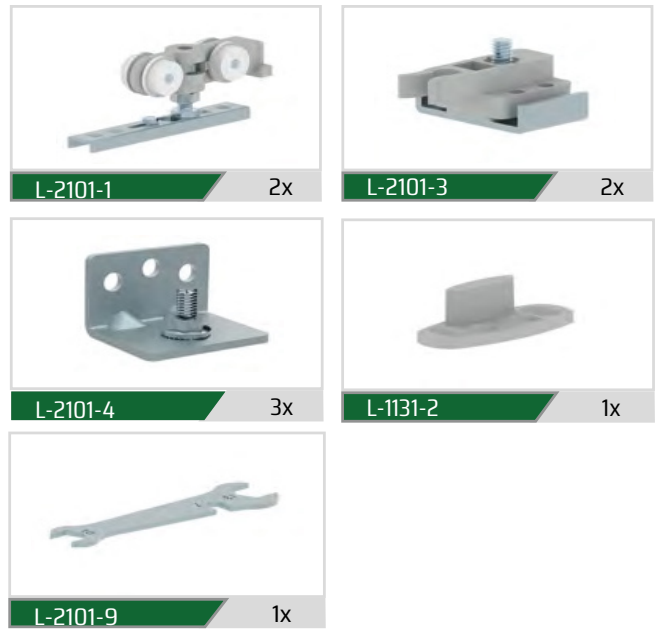

Kod	T (mm)	Koli	Volume (m ³)	Ağırlık (kg)	Birim /
L-2101	18-50	36	0,027	16,7	1Tk-1Kapak

Teknik Çizim	Kod	T (mm)	Bağ Band	Volume (m ³)	Ağırlık (kg)	
<p>Alüminyum Üst Ray</p>	L-3127-1	2.00	10	0,0245	0,900	Adet
	L-3127-3	3.00		0,0288	1,602	
<p>PVC Altı Ray</p>	L-3703	3.00	50	0,0225	0,200	Adet

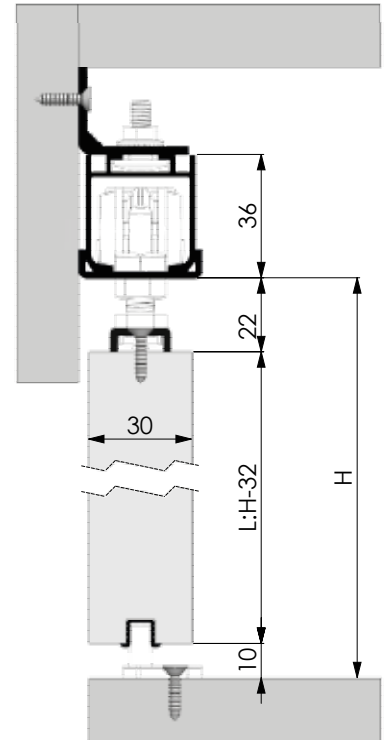



1 Set İçeriği |

LC99 Üstten Montaj

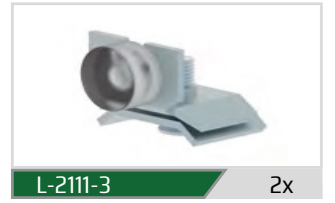

Kod	T (mm)	Koli	Volume (m ³)	Ağırlık (kg)	Birim /
L-2111	18-50	36	0,027	27,16	1Tk-1Kapak

Teknik Çizim	Kod	T (mt)	Bağ Band	Volume (m ³)	Ağırlık (kg)	
<p>Alüminyum Üst Ray</p>	L-3128-1	2.00	10	0,405	1,100	Adet
	L-3128-3	3.00		0,06075	1,700	
<p>PVC Alt Ray</p>	L-3703	3.00	50	0,0225	0,200	Adet

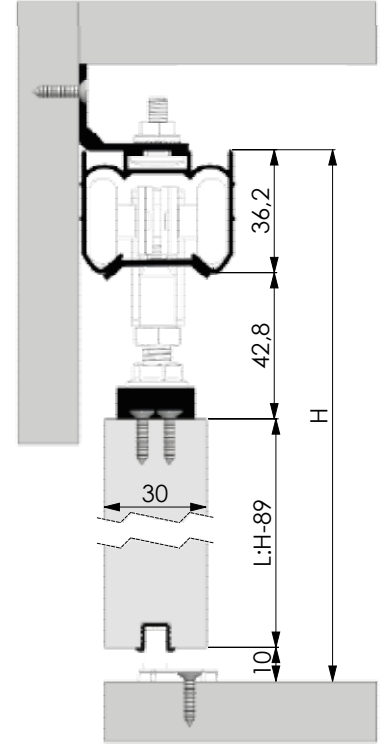



1 Set İçeriği |

LC120 Çiftli & Tekli



Kod	T (mm)	Koli	Volume (m ³)	Ağırlık (kg)	Birim /
L-2121	18-60	20	0,063	16,4	1Tk - 1Kapak

Teknik Çizim	Kod	T (mt)	Bağ Band	Volume (m ³)	Ağırlık (kg)	Adet
<p>Alüminyum Üst Ray</p>	L-3175-1	2.00	8	0,0216	2,232	Adet
	L-3175-3	3.00		0,0324	3,348	
	L-3175-4	4.00		0,0432	4,464	
<p>Alüminyum Ort Ray</p>	L-3176-1	2.00	10	0,0162	0,768	Adet
	L-3176-3	3.00		0,0243	1,152	
<p>PVC Alt Ray</p>	L-3703	3.00	50	0,0225	0,200	Adet

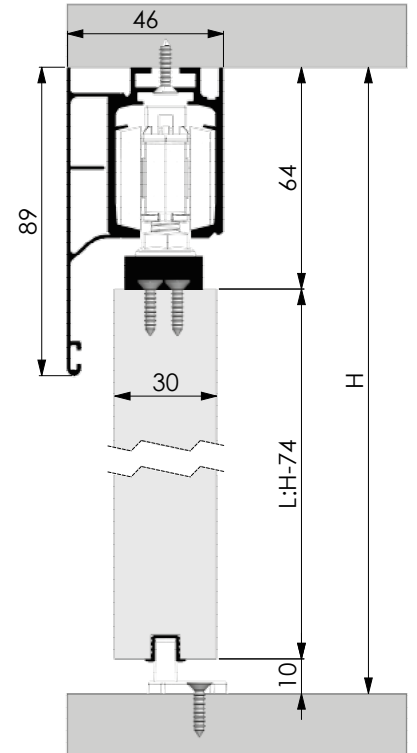

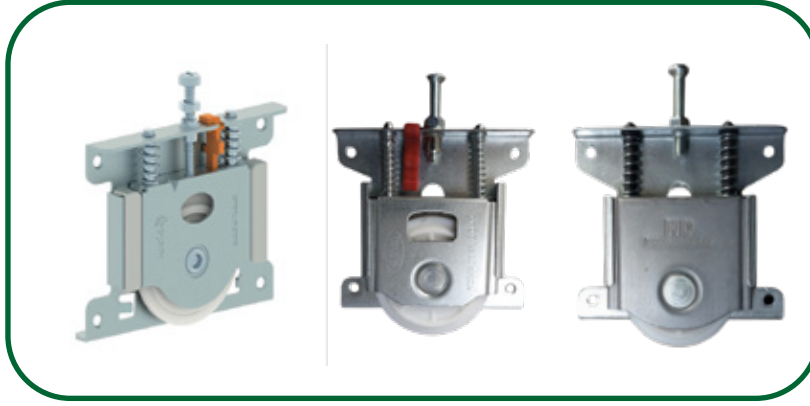

KOD	ÜRÜN AÇIKLAMASI	ADET
L-1151	PKM80 Dıştan Asma Makara Büyük LUCİDO	108
L-1272-1	PKM80 Dıştan Asma Makara Küçük LUCİDO	144
PKM-80	PKM80 Dıştan Asma Makara Kilitli	200
PKM-80-8	PKM80 Dıştan Asma Makara	200

<p>KOD Led Profili 15x11mm E4339</p>	<p>KOD Led Profili 14x8mm E4338</p>
<p>KOD AL-2001</p>	<p>KOD E1090</p>
<p>KOD E4898</p>	<p>KOD E1413/2 E1413/1</p> <p>ÜRÜN ADI Parlak Kimyasal</p>

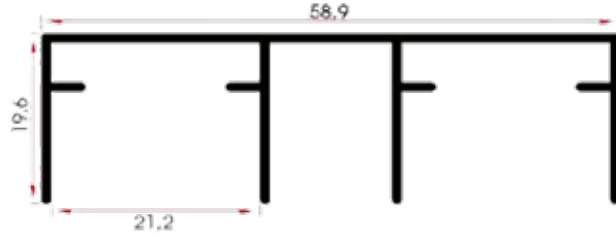

KOD

E1105

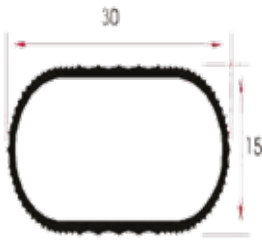

KOD

E1125



KOD

E1044

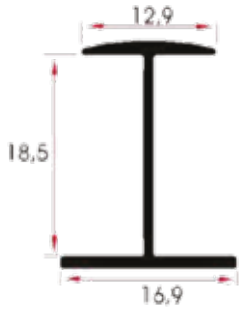

KOD

E3803/1

Parlak



KOD

E1194



KOD

E4049

Mat

E4049/1

Parlak



KOD

E1100

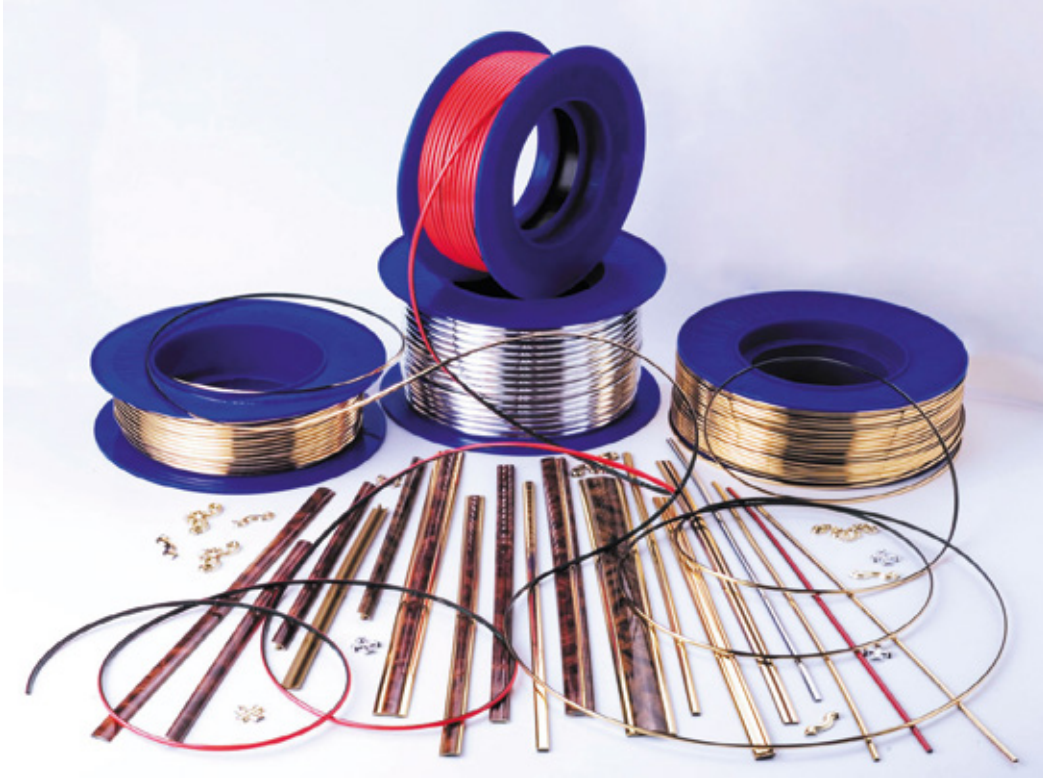

KOD	ÜRÜN AÇIKLAMASI	ADET
09G	Elkament Profil 9mm Gold	100
M03	Elkament M03 Krom	100
M10	Elkament M10 Krom	125
M26	Elkament M26 Krom	50
R-901/1	PVC Rijit Profil 5*4 mm Gold	120
R-904	PVC Rijit Profil 6*2 mm Gümüş	450
R-904/1	PVC Rijit Profil 6*2 mm Siyah	450
R-907	PVC Rijit Profil 10 mm Gold	240
R-907/1	PVC Rijit Profil 10 mm Mat Siyah	240
R-908	PVC Rijit Profil 10 mm Gümüş	240
R-909	PVC Rijit Profil 12 mm Gold	240
R-910	PVC Rijit Profil 12 mm Gümüş	240
R-915	PVC Rijit Profil 15 mm Gold	195
R-916	PVC Rijit Profil 15 mm Gümüş	195
R-918	PVC Rijit Profil 18 mm Gold	150
R-919	PVC Rijit Profil 18 mm Gümüş	150
R-928	PVC Rijit Profil 25 mm Gold	135
R-928/1	PVC Rijit Profil 25 mm Gümüş	135

 2311 INOKS
  2310A KROM
  2150K BEYAZ

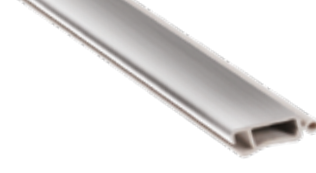
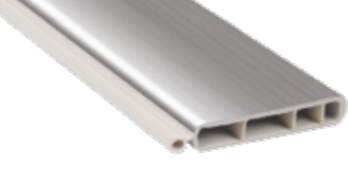
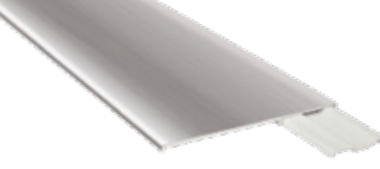
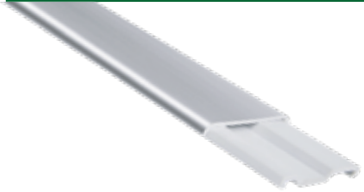
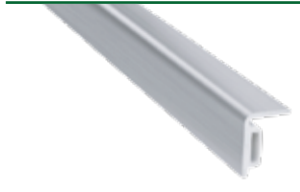
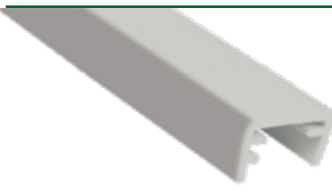
PROFİL	KOD	ÜRÜN AÇIKLAMASI	RENKLER
	0629/42	STOR KAPAK PROFİLİ 50 Boy 3 mt	2150K 2310A 2311
	ET-05025	KULP BAĞLAMA PROFİLİ 30 Boy 3 mt	2150K 2310A 2311
	179-K	STOR KULP PROFİLİ 50 Boy 3 mt	2150K 2310A 2311
	ET-05047	DIŞTAN TAKMA ALIN KAPAMA PROFİLİ 25 Boy 3 mt	2150K 2310A 2311
	182-K	YAN CUMBA KAPAMA PROFİLİ 50 Boy 3 mt	2150K 2310A 2311
	183-K	STOR ALT CUMBA KAPAMA PROFİLİ 50 Boy 3 mt	2150K 2310A 2311
	0630/42	ESK STOR U KANAL 50 Boy 3 mt	2150K 2310A 2311
	183-K	DSK STOR U KANALI 50 Boy 3 mt	1279

 2311 INOKS  2310A KROM  2150K BEYAZ

PROFİL KOD ÜRÜN İSMİ RENKLER

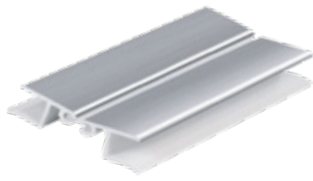

BK-10

100 mm

İÇ-DIŞ AÇILI KÖŞE APARATI

1 Kutu 25 Ad.

2311
2310A
2150K

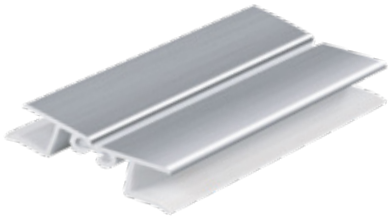

BK-12

120 mm

İÇ-DIŞ AÇILI KÖŞE APARATI

1 Kutu 25 Ad.

2311
2310A
2150K

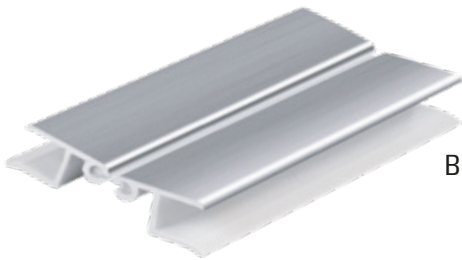

BK-15

150 mm

İÇ-DIŞ AÇILI KÖŞE APARATI

1 Kutu 25 Ad.

2311
2310A
2150K

● 2311
İNOKS

● 2310A
KROM

○ 2150K
BEYAZ

PROFİL	KOD	ÜRÜN İSMİ	RENKLER
	180	50 cm STOR SARGI MEKANİZMASI 50 Takım	1279
	0638/08	STOR KÖŞE DÖNÜŞ APARATI 50 Adet	1279
	0638/01	150 cm STOR SARGI MEKANİZMASI 50 Takım	1279
	184	200 cm STOR SARGI MEKANİZMASI 50 Takım	1279

1279
GRI

 1127
SIYAH

 2310P
KROM

 1120
BEYAZ



 1201
KREMT

 2311
INOKS

 2150K
BEYAZ

PROFİL	KOD	ÜRÜN İSMİ	RENKLER
	ET-03939	İÇ BÜKEY TEZGAH SÜPÜRGELİĞİ 24 Boy3,66 mt	1127 1279 1201 1120 2310P 2311 2150K
	ET-03121	İÇ BÜKEY TEZGAH SÜPÜRGELİĞİ İÇ KÖŞE APARATI 1 Kutu 100 Ad..	SÜPÜRGELİK RENKLERİNDE
	ET-03122	İÇ BÜKEY TEZGAH SÜPÜRGELİĞİ DIŞ KÖŞE APARATI 1 Kutu(100 Ad..	SÜPÜRGELİK RENKLERİNDE
	ET-03123	İÇ BÜKEY TEZGAH SÜPÜRGELİĞİ SAĞ-SOL KAPAK 1 Kutu 100 Ad..	SÜPÜRGELİK RENKLERİNDE
	R-18	MİNİ TEZGAH SÜPÜRGELİĞİ 24 Boy 3,66 mt	2310P 2311

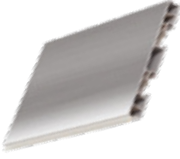
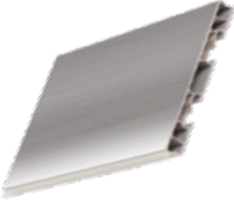
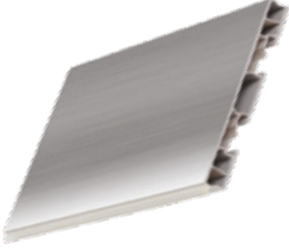
 2311 INOKS
  2310A KROM
  2150K BEYAZ

PROFİL	KOD	ÜRÜN İSMİ	RENKLER
	ET-05389	100 mm MUTFAK BAZA PROFİLİ 12 Boy 3,66 mt	2311 2310A 2150K
	ET-05387	120 mm MUTFAK BAZA PROFİLİ 12 Boy 3,66 mt	2311 2310A 2150K
	ET-04974	150 mm MUTFAK BAZA PROFİLİ 12 Boy 3,66 mt	2311 2310A 2150K
	ET-05892	KISA BAZA KLİPSİ 100-120-150 mm 1 Kutu 100 Ad	1127
	ET-05024	UZUN BAZA KLİPSİ 100-120-150 mm 1 Kutu 100 Ad	1127



KOD	ÜRÜN AÇIKLAMASI	ADET
8052/1	Aspiratör Inox Hibsan	1
8052	Aspiratör Beyaz Hibsan	1



KOD	ÜRÜN AÇIKLAMASI	ADET
SD54	Davlumbaz Eurostar	1



KOD	ÜRÜN AÇIKLAMASI	ADET
ET-00601	Aspiratör Karbon Filtre	1
ET-00602	Davlumbaz Karbon Filtre	1
ET-05332	Spiral Aspiratör Borusu 2 mt	1
ET-05524	Spiral Aspiratör Borusu 10 mt	1

KOD	ÜRÜN AÇIKLAMASI	ADET
ET-05386	Kaşıklık Oval Kumlu 30x49	12
ET-03312	Kaşıklık Oval Parlak 30x49	15



KOD	ÜRÜN AÇIKLAMASI	ADET
ET-06636	Kaşıklık Oval Kumlu 37x49	12
K-005	Kaşıklık Oval 37x49 EKO	15

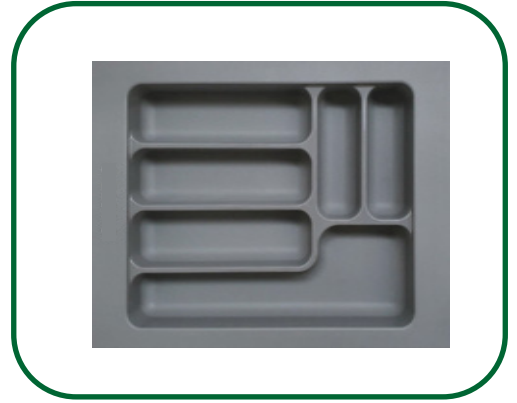

KOD	ÜRÜN AÇIKLAMASI	ADET
ET-06637	Kaşıklık Oval Kumlu 42x49	12
K-008	Kaşıklık Oval 42x49 EKO	15



KOD	ÜRÜN AÇIKLAMASI	ADET
ET-06638	Kaşıklık Oval Kumlu 47x49	12
K-11	Kaşıklık Oval 47x49 EKO	15





KOD	ÜRÜN AÇIKLAMASI	ADET
ET-06639	Kaşıklık Oval Kumlu 55x49	12
K-14	Kaşıklık Oval 55x49 EKO	15



KOD	ÜRÜN AÇIKLAMASI	ADET
ET-06652	Kaşıklık Oval Kumlu 62x49	12
K-62	Kaşıklık Oval 62x49 EKO	15



KOD	ÜRÜN AÇIKLAMASI	ADET
ET-06640	Kaşıklık Oval Kumlu 67x49	12
K-17	Kaşıklık Oval 67x49 EKO	15



KOD	ÜRÜN AÇIKLAMASI	ADET
ET-06666	Kaşıklık Oval Kumlu 75x49	12
K-20	Kaşıklık Oval 75x49 EKO	12

KOD	ÜRÜN AÇIKLAMASI	ADET
P9151	Çöp Kovası Paslanmaz VENT	1
S-2251-SS	Çöp Kovası Paslanmaz STARAX	1



KOD	ÜRÜN AÇIKLAMASI	ADET
P9152	Teleskopik Raylı Çöp Kovası Gri 12+12 Lt VENT	1
S-2392-G	Teleskopik Raylı Çöp Kovası Gri 12+12 Lt STARAX	1



KOD	ÜRÜN AÇIKLAMASI	ADET
P9154	Teleskopik Raylı Çöp Kovası Gri 16+1 Lt VENT	1
S-2391-G	Teleskopik Raylı Çöp Kovası Gri 16+1 Lt STARAX	1



KOD	ÜRÜN AÇIKLAMASI	ADET
P9156	Teleskopik Raylı Çöp Kovası Gri 24 Lt VENT	1
S-2572-G	Teleskopik Raylı Çöp Kovası Gri 24 Lt STARAX	1





VENT

KOD	ÜRÜN AÇIKLAMASI	ADET
P9453	Paslanmaz Çöp Kovası Gri 24 Lt	1



VENT

KOD	ÜRÜN AÇIKLAMASI	ADET
P9455	Paslanmaz Çöp Kovası Gri 12+12 Lt	1



KOD	ÜRÜN AÇIKLAMASI	ADET
ET-06793-1	Evye Altı 50 cm	15
ET-06793	Evye Altı 60 cm	15
ET-06793-2	Evye Altı 70 cm	15
ET-06793-3	Evye Altı 80 cm	15
ET-06793-4	Evye Altı 90 cm	15
ET-06793-5	Evye Altı 100 cm	15
ET-06793-7	Evye Altı 110 cm	15
ET-06793-6	Evye Altı 120 cm	15

KOD	ÜRÜN AÇIKLAMASI	ADET
P9001	Yandan Raylı Frenli Şişelik 10 cm VENT	1
P9005	Yandan Raylı Frenli Şişelik 16 cm VENT	1
P9006	Yandan Raylı Frenli Şişelik 22 cm VENT	1
31234	Yandan Raylı Şişelik 16 cm DOMODEK	1
31235	Yandan Raylı Şişelik 20 cm DOMODEK	1
31236	Yandan Raylı Şişelik 25 cm DOMODEK	1

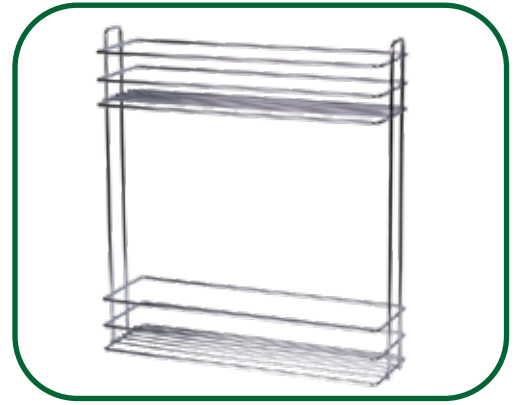

KOD	ÜRÜN AÇIKLAMASI	ADET
P9052	Döner Köşe 3/4 74 cm VENT	1
23068	Döner Köşe 3/4 72 cm DOMODEK	1
23066	Döner Köşe 3/4 56 cm DOMODEK	1
23201	Döner Köşe 3/4 82 cm DOMODEK	1



KOD	ÜRÜN AÇIKLAMASI	ADET
P9054	Döner Köşe 4/4 60 cm VENT	1
P9055	Döner Köşe 4/4 72 cm VENT	1
24067	Döner Köşe 4/4 56 cm DOMODEK	1
24069	Döner Köşe 4/4 72 cm DOMODEK	1

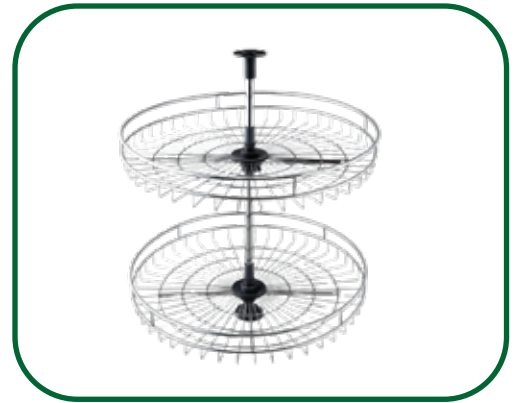

KOD	ÜRÜN AÇIKLAMASI	ADET
24961	4/4 Ahşap Tabanlı Döner Köşe 56 cm	1
24962	4/4 Ahşap Tabanlı Döner Köşe 72 cm	1
23961	4/3 Ahşap Tabanlı Döner Köşe 56 cm	1
23962	4/3 Ahşap Tabanlı Döner Köşe 72 cm	1



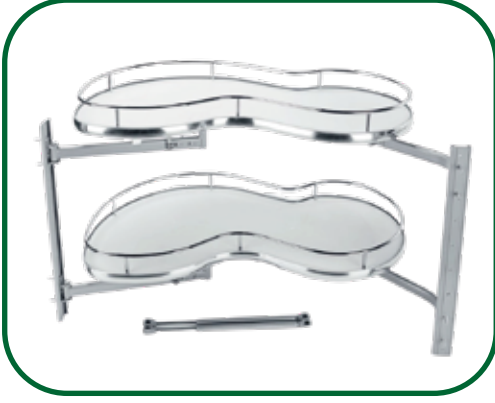

KOD	ÜRÜN AÇIKLAMASI	ADET
P906	Elips Kör Köşe Fasulye Frenli SAĞ-SOL MODERNO	1
S-3013-C	Elips Kör Köşe Fasulye Frenli SAĞ-SOL STARAX	1



KOD	ÜRÜN AÇIKLAMASI	ADET
P-9202	Gardrop Asansörü MODERNO	1
S-6014-G	Gardrop Asansörü 15 Kg STARAX	1
ET-05373	Gardrop Asansörü HANDLES	1



DOMODEK

KOD	ÜRÜN AÇIKLAMASI	ADET
79080	Kapağa Monte Çamaşır Sepeti 30 Mod	2
79081	Kapağa Monte Çamaşır Sepeti 35 Mod	2
79082	Kapağa Monte Çamaşır Sepeti 40 Mod	2
79083	Kapağa Monte Çamaşır Sepeti 45 Mod	2
79084	Kapağa Monte Çamaşır Sepeti 50 Mod	2
79085	Kapağa Monte Çamaşır Sepeti 55 Mod	2
79086	Kapağa Monte Çamaşır Sepeti 60 Mod	2
79087	Kapağa Monte Çamaşır Sepeti 65 Mod	2

KOD	ÜRÜN AÇIKLAMASI	ADET
ALM-2009	Banyo Köşe Rafı Paslanmaz Kare Tekli	1
Krom - Gold - Siyah		



KOD	ÜRÜN AÇIKLAMASI	ADET
ALM-2001	Banyo Köşe Rafı Paslanmaz Tekli	1
Krom - Gold - Siyah		

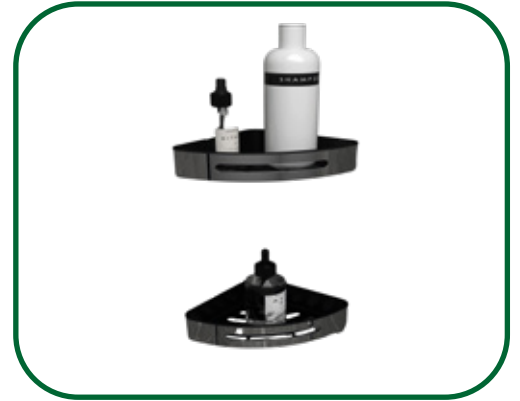

KOD	ÜRÜN AÇIKLAMASI	ADET
ALM-2015	Lüks Askılık 3'lü - 4'lü - 5'li	1
Krom - Siyah - Beyaz		





KOD	ÜRÜN AÇIKLAMASI	ADET
ALM-2004	Banyo Köşe Rafı Paslanmaz İkilili	1
Krom - Gold - Siyah		



KOD	ÜRÜN AÇIKLAMASI	ADET
ALM-2007	Banyo Köşe Rafı Paslanmaz Üçlü	1
Krom - Gold - Siyah		



KOD	ÜRÜN AÇIKLAMASI	ADET
ALM-2015	Banyo Köşe Rafı Paslanmaz Kare Üçlü	1
Krom - Gold - Siyah		

KOD	ÜRÜN AÇIKLAMASI	ADET
ET-00150	Askı Borusu Krom Yuvarlak 3mt	20
ET-00149	Askı Borusu Krom Oval 3mt	20

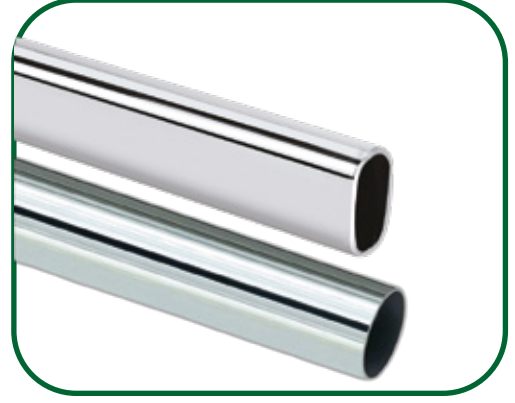

FLORE

KOD	ÜRÜN AÇIKLAMASI	ADET
ET-05207	Raf Altı 5*6 100 mm-150 mm Beyaz - Siyah	2 düzine
ET-05208	Raf Altı 6*8 130 mm-190 mm Beyaz - Siyah	2 düzine
ET-05209	Raf Altı 7*9 165 mm-225 mm Beyaz - Siyah	2 düzine
ET-05210	Raf Altı 8*10 195 mm-265 mm Beyaz - Siyah	2 düzine
ET-05211	Raf Altı 10*12 230 mm-300 mm Beyaz - Siyah	2 düzine
ET-05212	Raf Altı 12*14 260 mm-330 mm Beyaz - Siyah	2 düzine



FLORE

KOD	ÜRÜN AÇIKLAMASI	ADET
ET-06309	Ferforje No:1 100 mm-155mm Bakır	20
ET-06309/1	Ferforje No:2 135 mm-190mm Bakır	20
ET-06309/2	Ferforje No:3 155 mm-230mm Bakır	20
ET-06308	Ferforje No:1 100 mm-155mm Beyaz	20
ET-06308/1	Ferforje No:2 135 mm-190mm Beyaz	20
ET-06308/2	Ferforje No:3 155 mm-230mm Beyaz	20
ET-06307	Ferforje No:1 100 mm-155mm Siyah	20
ET-06307/1	Ferforje No:2 135 mm-190mm Siyah	20
ET-06307/2	Ferforje No:3 155 mm-230mm Siyah	20





KOD	ÜRÜN AÇIKLAMASI	ADET
4106-01	Rakam Krom	36
4106-04	Rakam Altın	36
4106-02	Rakam Saten	36



KOD	ÜRÜN AÇIKLAMASI	ADET
4107-01	Cam Menteşesi Krom 6mm	32



KOD	ÜRÜN AÇIKLAMASI	ADET
4109-01	Cam Kulbu Krom	32

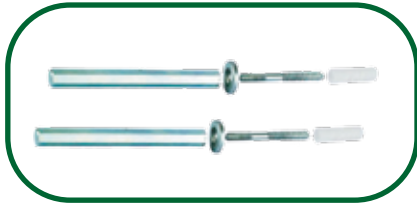

KOD	ÜRÜN AÇIKLAMASI	ADET
72137	Gizli Raf Tutucu 14cm	50
72145	Gizli Raf Tutucu 10 cm	50
72149	Gizli Raf Tutucu 14cm (18mm)	50
72148	Gizli Raf Tutucu 10 cm (18mm)	50



KOD	ÜRÜN AÇIKLAMASI	ADET
4147-01	Anahtar Askısı Krom	100
4146-01	Kablo Gizleyici Krom	50



KOD	ÜRÜN AÇIKLAMASI	ADET
4108-01	Cam Menteşesi Krom 6mm	32



KOD	ÜRÜN AÇIKLAMASI	ADET
4115-01	Tij Boru Bağlantısı	72
4119-01	Tij Boru Tapası	200
4117-01	Tij Boru S Kanca	100
89149	Tij Boru 40 cm	10
89150	Tij Boru 50 cm	10
89151	Tij Boru 60 cm	10
89152	Tij Boru 70 cm	10
89153	Tij Boru 100 cm	10
89154	Tij Boru 120 cm	10



KOD	ÜRÜN AÇIKLAMASI	ADET
2100-01	Raf Tutucu 4-30 Krom	12



KOD	ÜRÜN AÇIKLAMASI	ADET
2103-01	Ayarlı Raf Tutucu 4-20 mm	48
72103-01	Eko Ayarlı Raf Tutucu 4-20 mm	48



KOD	ÜRÜN AÇIKLAMASI	ADET
2101-01	Ayarlı Etejer Çift	12



KOD	ÜRÜN AÇIKLAMASI	ADET
2104-01	Ayarlı Raf Tutucu Orta Boy	48
72104-01	Eko Ayarlı Raf Tutucu Orta Boy	48



KOD	ÜRÜN AÇIKLAMASI	ADET
2106-01	Raf Tutucu 8 mm	100



KOD	ÜRÜN AÇIKLAMASI	ADET
2105-01	Ayarlı Etejer Büyük Boy	12



KOD	ÜRÜN AÇIKLAMASI	ADET
7100-01	Raf Tutucu 10 mm	100



KOD	ÜRÜN AÇIKLAMASI	ADET
72135-01	Raf Tutucu 10 mm	48



KOD	ÜRÜN AÇIKLAMASI	ADET
2002.01	Plastik Çektirme Beyaz METALİ	1800
2002	Plastik Çektirme Şeffaf METALİ	1800
V144	Plastik Çektirme Şeffaf VOLKAN	1800



KOD	ÜRÜN AÇIKLAMASI	ADET
4003	Yuvarlak Şeffaf Boru Flanşı	100



KOD	ÜRÜN AÇIKLAMASI	ADET
5005	Yuvarlak Raf Pimi Şeffaf	1000
5005.01	Yuvarlak Raf Pimi Beyaz	1000



KOD	ÜRÜN AÇIKLAMASI	ADET
5004	Ayna Tutucu Şeffaf	100



KOD	ÜRÜN AÇIKLAMASI	ADET
5006	Düz Raf Pimi Şeffaf	1000



KOD	ÜRÜN AÇIKLAMASI	ADET
5001	Cam etejeri 22,5 mm Şeffaf	50
5001/1	Cam etejeri 22,5 mm Beyaz	50
5001.02	Cam etejeri 22,5 mm Krem	50



KOD	ÜRÜN AÇIKLAMASI	ADET
4006	Köşeli Oval Flanş Şeffaf	100
4004	Oval Flanş Şeffaf	100



KOD	ÜRÜN AÇIKLAMASI	ADET
5004	Ayna Tutucu Şeffaf 4mm	100
5002	Ayna Tutucu Şeffaf 8mm	100



KOD	ÜRÜN AÇIKLAMASI	ADET
1001	Modül Askı Elemanı Daset Beyaz Sağ- Sol	100



KOD	ÜRÜN AÇIKLAMASI	ADET
3001	Duvar Kapı Tamponu Şeffaf	120



KOD	ÜRÜN AÇIKLAMASI	ADET
3002	Zemin Kapı Tamponu 35mm	120



KOD	ÜRÜN AÇIKLAMASI	ADET
V144	Plastik Çektirme Şeffaf	1800
V144-B	Plastik Çektirme Beyaz	1800



KOD	ÜRÜN AÇIKLAMASI	ADET
V138-CI	Açılı Metal Çektirme Çinko	100



KOD	ÜRÜN AÇIKLAMASI	ADET
V139-CI	Kelebek Metal Çektirme Çinko	100



KOD	ÜRÜN AÇIKLAMASI	ADET
V103-CI	Eğri Metal Çektirme Çinko	100



KOD	ÜRÜN AÇIKLAMASI	ADET
V101	Metal Çektirme Küçük Sarı / Beyaz	100
V102	Metal Çektirme Büyük Sarı / Beyaz	100



KOD	ÜRÜN AÇIKLAMASI	ADET
V691	Plastik Kelebek Somun M8	500
V692	Plastik Kelebek Somun 5/16	500

KOD	ÜRÜN AÇIKLAMASI	ADET
V101-S	Metal Çektirme Şablonu	1
V103-S	Eğri Metal Çektirme Şablonu	1
V138-S	Açılı Metal Çektirme Şablonu	1
V139-S	Kelebek Metal Çektirme Şablonu	1



KOD	ÜRÜN AÇIKLAMASI	ADET
V104	L Civata	50



KOD	ÜRÜN AÇIKLAMASI	ADET
V105	Metal Tırnaklı Çektirme Çinko	100



KOD	ÜRÜN AÇIKLAMASI	ADET
V109	Bilyalı Çit Çit	10 Takım

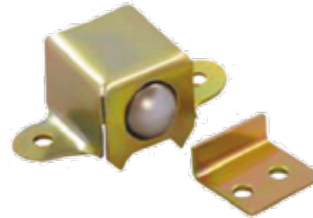

KOD	ÜRÜN AÇIKLAMASI	ADET
V106	Plastik Tırnaklı Çektirme	100



KOD	ÜRÜN AÇIKLAMASI	ADET
V107	Köprü Bağlantı	100





KOD	ÜRÜN AÇIKLAMASI	ADET
V108	Plastik Kapaklı Köşe Bağlantı	100



KOD	ÜRÜN AÇIKLAMASI	ADET
V141	Plastik L Köşe Bağlantı	250

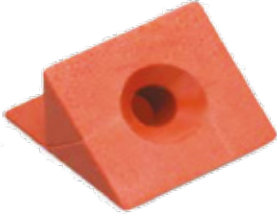

KOD	ÜRÜN AÇIKLAMASI	ADET
V140	Arkalık Pimi	1000



KOD	ÜRÜN AÇIKLAMASI	ADET
V142	Plastik Kavalje Siyah 8x30	1000
V143	Plastik Kavalje Beyaz 8x30	1000



KOD	ÜRÜN AÇIKLAMASI	ADET
V202	Gizli Raf Tutucu 10x100mm	1 takım
V215	Gizli Raf Tutucu 8x100mm	1 takım



KOD	ÜRÜN AÇIKLAMASI	ADET
V203	Gizli Raf Tutucu 10x140 mm	1 takım
V216	Gizli Raf Tutucu 8x140 mm	1 takım



KOD	ÜRÜN AÇIKLAMASI	ADET
V201	Mutfak Askı Elemanı	200

KOD	ÜRÜN AÇIKLAMASI	ADET
V110-CI	Metal Dübelli Minifix Çinko (8x13)	250
V110-NI	Metal Dübelli Minifix Nikel (8x13)	250



KOD	ÜRÜN AÇIKLAMASI	ADET
V111-CI	Metal Dübelli Minifix Çinko (8x11)	250
V111-NI	Metal Dübelli Minifix Nikel (8x11)	250



KOD	ÜRÜN AÇIKLAMASI	ADET
V112-CI	Plastik Dübelli Minifix Çinko (10x13)	250
V112-NI	Plastik Dübelli Minifix Nikel (10x13)	250



KOD	ÜRÜN AÇIKLAMASI	ADET
V113-CI	Plastik Dübelli Minifix Çinko (8x11)	250
V113-NI	Plastik Dübelli Minifix Nikel (8x11)	250



KOD	ÜRÜN AÇIKLAMASI	ADET
V114-CI	Minifix Gövde Çinko	1000
V114-NI	Minifix Gövde Nikel	1000



KOD	ÜRÜN AÇIKLAMASI	ADET
V115	Minifix Mili	1000



KOD	ÜRÜN AÇIKLAMASI	ADET
V124	Açılı Minifix Mili	250





KOD	ÜRÜN AÇIKLAMASI	ADET
V129-CI	Metal Dübelli Volfix Çinko (8x13)	250
V129-NI	Metal Dübelli Volfix Nikel (8x13)	250



KOD	ÜRÜN AÇIKLAMASI	ADET
V130-CI	Metal Dübelli Volfix Çinko (8x11)	250
V130-NI	Metal Dübelli Volfix Nikel (8x11)	250



KOD	ÜRÜN AÇIKLAMASI	ADET
V131-CI	Plastik Dübelli Volfix Çinko (10x13)	250
V131-NI	Plastik Dübelli Volfix Nikel (10x13)	250



KOD	ÜRÜN AÇIKLAMASI	ADET
V132-CI	Plastik Dübelli Volfix Çinko (8x11)	250
V132-NI	Plastik Dübelli Volfix Nikel (8x11)	250



KOD	ÜRÜN AÇIKLAMASI	ADET
V135-CI	Volfix Gövde Çinko	1000
V135-NI	Volfix Gövde Nikel	1000



KOD	ÜRÜN AÇIKLAMASI	ADET
V136	Volfix Mili	1000



KOD	ÜRÜN AÇIKLAMASI	ADET
V125	Boydan Fix Mili (7x68 mm)	250
V126	Boydan Fix Mili (7x68 mm) Segmanlı	250
V127	Boydan Fix Mili (7x86 mm)	250
V128	Boydan Fix Mili (7x86 mm) Segmanlı	250

KOD	ÜRÜN AÇIKLAMASI	ADET
V133-CI	Kendinden Dübelli Minifix Çinko 8'lik	1000
V133-NI	Kendinden Dübelli Minifix Nikel 8'lik	1000

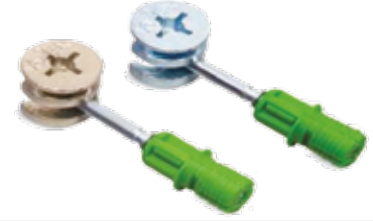

KOD	ÜRÜN AÇIKLAMASI	ADET
V134-CI	Kendinden Dübelli Minifix Çinko 10'luk	1000
V134-NI	Kendinden Dübelli Minifix Nikel 10'luk	1000



KOD	ÜRÜN AÇIKLAMASI	ADET
V145-CI	Kendinden Dübelli Volfix Çinko 8'lik	1000
V133-NI	Kendinden Dübelli Volfix Nikel 8'lik	1000

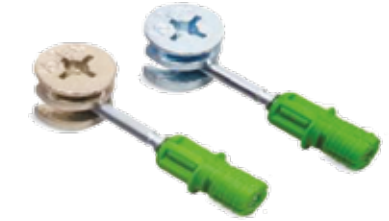

KOD	ÜRÜN AÇIKLAMASI	ADET
V146-CI	Kendinden Dübelli Volfix Çinko 10'luk	1000
V146-NI	Kendinden Dübelli Volfix Nikel 10'luk	1000

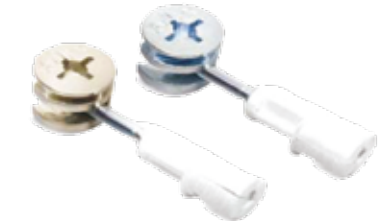

KOD	ÜRÜN AÇIKLAMASI	ADET
V117	Metal Dübel M6 (8x13)	1000
V118	Metal Dübel M6 (8x11)	1000
V119	Metal Dübel M8 (10x20)	1000
V160	Metal Dübel M8 (10x18)	1000
V120	Metal Dübel M8 (10x15)	1000



KOD	ÜRÜN AÇIKLAMASI	ADET
V122	Plastik Dübel M6 (10x13)	1000
V123	Plastik Dübel M6 (8x11)	1000





KOD	ÜRÜN AÇIKLAMASI	ADET
V303	Çift Contalı Raf Pimi (5mm)	2000
V304	Contalı Cam Raf Pimi (5mm)	2000



KOD	ÜRÜN AÇIKLAMASI	ADET
V305	Çivili Cam Raf Pimi (5mm)	2000
V302	Segmanlı Raf Pimi (5mm)	2000



KOD	ÜRÜN AÇIKLAMASI	ADET
V306	Vantuzlu Cam Raf Pimi (5mm)	100
V301	Metal Raf Pimi (5mm)	2000



KOD	ÜRÜN AÇIKLAMASI	ADET
V309	Apex Metal Raf Pimi (5mm)	2000
V310	Apex Pimli Metal Raf Pimi (5mm)	2000



KOD	ÜRÜN AÇIKLAMASI	ADET
V308	Ayarlı Metal Cam Raf Pimi Pimli	100
V307	Ayarlı Metal Cam Raf Pimi Düz	100



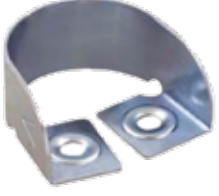

KOD	ÜRÜN AÇIKLAMASI	ADET
V204	Askı Flanşı İki Delikli Çinko	200
V205-CI	Askı Flanşı Dört Delikli Çinko	100
V205-KROM	Askı Flanşı Dört Delikli Krom	100



KOD	ÜRÜN AÇIKLAMASI	ADET
V206	Yuvarlak Boru Flanşı (Vidalı)	100
V209	Metal Kapaklı Askı Flanşı (Vidalı)	100



KOD	ÜRÜN AÇIKLAMASI	ADET
V207	Oval Boru Askı Flanşı Düz	100
V208	Oval Boru Askı Flanşı Pimli	100



KOD	ÜRÜN AÇIKLAMASI	ADET
V210	Oval Askı Boru Flanşı Düz	100
V211	Oval Askı Boru Flanşı Pimli	100



KOD	ÜRÜN AÇIKLAMASI	ADET
V212-M4	Uzun Oval Askı Boru Flanşı M4	100
V212-M6	Uzun Oval Askı Boru Flanşı M6	100



KOD	ÜRÜN AÇIKLAMASI	ADET
V213-A	Oval Boru Babası Açık	100
V231-K	Oval Boru Babası Kapalı	100



KOD	ÜRÜN AÇIKLAMASI	ADET
V214-A	Yuvarlak Boru Babası Açık	100
V214-K	Yuvarlak Boru Babası Kapalı	100





KOD	ÜRÜN AÇIKLAMASI	ADET
V654	Bingo Ayak Küçük	200



KOD	ÜRÜN AÇIKLAMASI	ADET
V653	Bingo Ayak Büyük	200



KOD	ÜRÜN AÇIKLAMASI	ADET
V652	Bingo Sağı	200



KOD	ÜRÜN AÇIKLAMASI	ADET
V688	Çivili Poligrit	1000



KOD	ÜRÜN AÇIKLAMASI	ADET
V689	Çivili Poligrit	1000



KOD	ÜRÜN AÇIKLAMASI	ADET
V690	Çivili Baza Pabucu	500

KOD	ÜRÜN AÇIKLAMASI	ADET
V402	Dübelli Karyola Demiri	10 Takım
V406	Dübelli Karyola Demiri Sacı	100

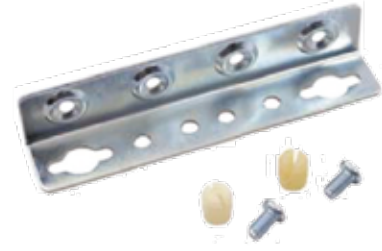

KOD	ÜRÜN AÇIKLAMASI	ADET
V401	Tırnaklı Karyola Demiri	10 Takım

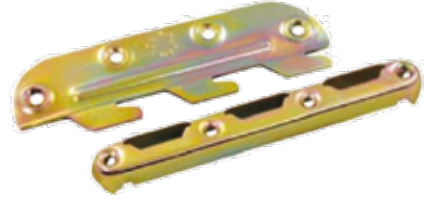

KOD	ÜRÜN AÇIKLAMASI	ADET
V405	Karyola Demiri 4 Delik 15 cm	10 Takım

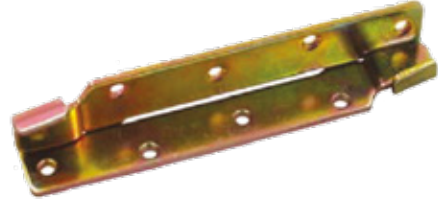

KOD	ÜRÜN AÇIKLAMASI	ADET
V403	Karyola Demiri Küçük 9 cm	10 Takım
V404	Karyola Demiri Büyük 12,5 cm	10 Takım



KOD	ÜRÜN AÇIKLAMASI	ADET
V503	Boy Menteşe Beyaz 175 cm	50
V501	Boy Menteşe Sarı 175 cm	50

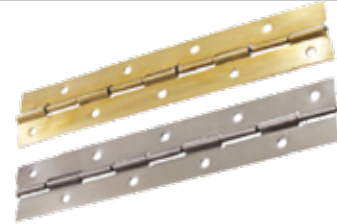

KOD	ÜRÜN AÇIKLAMASI	ADET
V506	Sandık Kulbu	1 Düzine
ET-05241	Sandık Kulbu Büyük	1 Düzine





KOD	ÜRÜN AÇIKLAMASI	ADET
V601	Metal Montebent 6x32 mm	250
V602	Metal Montebent 6x40 mm	250
V603	Metal Montebent 6x60 mm	250
V604	Metal Montebent 6x80 mm	250
V606	Metal Montebent Somunu	1000



KOD	ÜRÜN AÇIKLAMASI	ADET
V605	Mini Montebent Metal 5x30 mm	500



KOD	ÜRÜN AÇIKLAMASI	ADET
V620	Metrik Kulp Vidası 4x12 mm	2500
V621	Metrik Kulp Vidası 4x15 mm	2500
V622	Metrik Kulp Vidası 4x20 mm	2500
V623	Metrik Kulp Vidası 4x22 mm	2500
V624	Metrik Kulp Vidası 4x25 mm	2500
V625	Metrik Kulp Vidası 4x30 mm	2500
V626	Metrik Kulp Vidası 4x35 mm	2500
V627	Metrik Kulp Vidası 4x40 mm	2500
V628	Metrik Kulp Vidası 4x45 mm	2000
V629	Metrik Kulp Vidası 4x50 mm	2000
V630	Metrik Kulp Vidası 4x60mm	1000
V631	Metrik Kulp Vidası 4x70 mm	1000



KOD	ÜRÜN AÇIKLAMASI	ADET
V607	Allen Silindirik Çektirme Cviatası 6x30mm	250
V608	Allen Silindirik Çektirme Cviatası 6x40mm	250
V609	Allen Silindirik Çektirme Cviatası 6x50mm	250
V610	Allen Silindirik Çektirme Cviatası 6x60mm	250
V611	Allen Silindirik Çektirme Cviatası 6x70mm	250
V612	Allen Silindirik Çektirme Cviatası 6x80mm	250
V613	Silindirik Somun Ø 10 Boy 13 mm	1000
V651	Silindirik Somun Ø 14 Boy 14 mm	1000

KOD	ÜRÜN AÇIKLAMASI	ADET
V638	Allen Kör Somun M6	1000



KOD	ÜRÜN AÇIKLAMASI	ADET
V639	Masa Sandalye Somunu M6 10x18	1000
V655	Masa Sandalye Somunu M6 10x20	1000



KOD	ÜRÜN AÇIKLAMASI	ADET
V715	Pul 5/32 4'lik	1 Kg
V716	Pul 3/16 5'lik	1 Kg
V717	Pul 1/4 6'lik	1 Kg



KOD	ÜRÜN AÇIKLAMASI	ADET
V633	Kabin Vidası Yıldız Başlı	1000
V634	Kabin Vidası Allen Başlı	1000



KOD	ÜRÜN AÇIKLAMASI	ADET
V636	Ray Vidası 6,3x13	1000



KOD	ÜRÜN AÇIKLAMASI	ADET
V641	Çakma Ağaç Somunu M6	500
V642	Çakma Ağaç Somunu M8	500
V643	Çakma Ağaç Somunu M10	250





KOD	ÜRÜN AÇIKLAMASI	ADET
V618	Köşe Bağlantı 35x35 mm	250



KOD	ÜRÜN AÇIKLAMASI	ADET
V618-D	Düz Bağlantı 70 mm	250



KOD	ÜRÜN AÇIKLAMASI	ADET
V650	Oval Köşe Bağlantı 30x30 mm	250
ET-05377	Oval Köşe Bağlantı 30x30 mm Eko	250



KOD	ÜRÜN AÇIKLAMASI	ADET
V650-D	Oval Bağlantı Düz	250



KOD	ÜRÜN AÇIKLAMASI	ADET
V614	L Köşe Gönye 25x25 mm	250
V615	L Köşe Gönye 35x35 mm	250
V616	L Köşe Gönye 45x45 mm	250
V617	L Köşe Gönye 55x55 mm	250

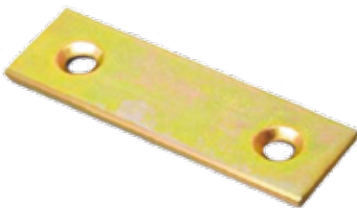

KOD	ÜRÜN AÇIKLAMASI	ADET
V614-D	Düz Gönye 50 mm	250
V615-D	Düz Gönye 70 mm	250
V616-D	Düz Gönye 90 mm	250
V617-D	Düz Gönye 110 mm	250

Genişlik 60mm

KOD	ÜRÜN AÇIKLAMASI	ADET
V674	Düz Gönye 120 mm	50
V675	Düz Gönye 160 mm	50
V676	Düz Gönye 200 mm	40
V677	Düz Gönye 240 mm	30



Genişlik 80mm

KOD	ÜRÜN AÇIKLAMASI	ADET
V678	Köşe Bağlantı 60x60 mm	50
V679	Köşe Bağlantı 80x80 mm	50
V680	Köşe Bağlantı 100x100 mm	40
V681	Köşe Bağlantı 120x120 mm	30



Genişlik 80mm

KOD	ÜRÜN AÇIKLAMASI	ADET
V684	Düz Gönye 120 mm	40
V685	Düz Gönye 160 mm	40
V686	Düz Gönye 200 mm	30
V687	Düz Gönye 240 mm	20



Genişlik 80mm

KOD	ÜRÜN AÇIKLAMASI	ADET
V682	Köşe Bağlantı 60x140 mm	30
V683	Köşe Bağlantı 80x160 mm	20





Genişlik 40mm

KOD	ÜRÜN AÇIKLAMASI	ADET
V656	Köşe Bağlantı 40x40 mm	150
V657	Köşe Bağlantı 60x60 mm	80
V658	Köşe Bağlantı 80x80 mm	50
V659	Köşe Bağlantı 100x100 mm	50
V660	Köşe Bağlantı 120x120 mm	40



Genişlik 40mm

KOD	ÜRÜN AÇIKLAMASI	ADET
V661	Köşe Bağlantı 60x140 mm	50
V662	Köşe Bağlantı 80x160 mm	40



Genişlik 40mm

KOD	ÜRÜN AÇIKLAMASI	ADET
V663	Düz Gönye 80 mm	150
V664	Düz Gönye 120 mm	80
V665	Düz Gönye 160 mm	50
V666	Düz Gönye 200 mm	50
V667	Düz Gönye 240 mm	40

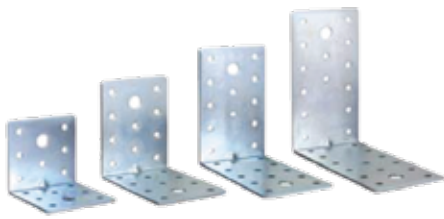

Genişlik 60mm

KOD	ÜRÜN AÇIKLAMASI	ADET
V668	Köşe Bağlantı 60x60 mm	50
V669	Köşe Bağlantı 80x80 mm	50
V670	Köşe Bağlantı 100x100 mm	40
V671	Köşe Bağlantı 120x120 mm	30



Genişlik 60mm

KOD	ÜRÜN AÇIKLAMASI	ADET
V672	Köşe Bağlantı 60x140 mm	40
V673	Köşe Bağlantı 80x160 mm	30

KOD	ÜRÜN AÇIKLAMASI	ADET
ET-06658	Nefes Ayak 12 Cm Beyaz & Kahve & Siyah	200
ET-06657	Nefes Ayak 15 Cm Beyaz & Kahve & Siyah	200



KOD	ÜRÜN AÇIKLAMASI	ADET
ET-06659	Narin Ayak 19 cm	200
Siyah & Altın - Kahve & Altın - Beyaz & Altın - Beyaz & Krom - Siyah & Krom		
ET-06662	Narin Ayak 16 cm	200
Siyah & Altın - Kahve & Altın - Beyaz & Altın - Beyaz & Krom - Siyah & Krom		

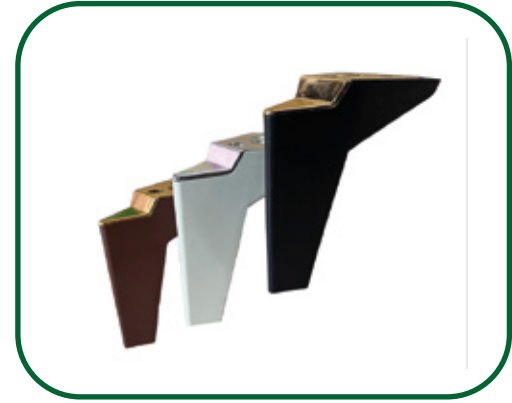

KOD	ÜRÜN AÇIKLAMASI	ADET
ET-06667	Kobra Ayak 16 Cm Krom - Altın	150
ET-06669	Kobra Ayak 19 Cm Krom - Altın	150



KOD	ÜRÜN AÇIKLAMASI	ADET
ET-06686	Orkide Ayak 14 cm	150
Beyaz - Siyah		





KOD	ÜRÜN AÇIKLAMASI	ADET
ET-00980-1	Jumbo Ayak 8 cm Siyah	200
ET-00980	Jumbo Ayak 8 cm Beyaz	200
ET-00980-2	Jumbo Ayak 8 cm Gri	200
ET-00979-1	Jumbo Ayak 10 cm Siyah	200
ET-00979	Jumbo Ayak 10 cm Beyaz	200
ET-00979-2	Jumbo Ayak 10 cm Gri	200



KOD	ÜRÜN AÇIKLAMASI	ADET
ET-06601	Yıldız Ayak 8 cm Siyah	125
ET-06602	Yıldız Ayak 10 cm Siyah	100
ET-06592	Yıldız Ayak 8 cm Beyaz	125
ET-06693	Yıldız Ayak 10 cm Beyaz	100
ET-06590	Yıldız Ayak 8 cm Saten	125
ET-06591	Yıldız Ayak 10 cm Saten	100

KOD	ÜRÜN AÇIKLAMASI	ADET
ET-06107	Ardıç Ayak 6 cm Mat Krom	100
ET-06108	Ardıç Ayak 8 cm Mat Krom	100
ET-06109	Ardıç Ayak 10 cm Mat Krom	100
ET-06107/1	Ardıç Ayak 6 cm Beyaz	100
ET-06108/1	Ardıç Ayak 8 cm Beyaz	100
ET-06109/1	Ardıç Ayak 10 cm Beyaz	100



KOD	ÜRÜN AÇIKLAMASI	ADET
ET-06098	U Meşe Ayak 6 cm Mat Krom	100
ET-06099	U Meşe Ayak 8 cm Mat Krom	100
ET-06100	U Meşe Ayak 10 cm Mat Krom	100
ET-06098/1	U Meşe Ayak 6 cm Beyaz	100
ET-06099/1	U Meşe Ayak 8 cm Beyaz	100
ET-06100/1	U Meşe Ayak 10 cm Beyaz	100



KOD	ÜRÜN AÇIKLAMASI	ADET
ET-06088/1	Çınar Ayak Çizgili 6 cm Beyaz	100
ET-06088	Çınar Ayak Çizgili 8 cm Beyaz	100
ET-06089	Çınar Ayak Çizgili 10 cm Beyaz	100



KOD	ÜRÜN AÇIKLAMASI	ADET
ET-06777	Titan Ayak 6 cm Mat Krom	100
ET-06778	Titan Ayak 8 cm Mat Krom	100
ET-06779	Titan Ayak 10 cm Mat Krom	100
ET-06825	Titan Ayak 12 cm Mat Krom	100





KOD	ÜRÜN AÇIKLAMASI	ADET
ET-06092	Ladin Ayak 6 cm Mat Krom	100
ET-06093	Ladin Ayak 8 cm Mat Krom	100
ET-06094	Ladin Ayak 10 cm Mat Krom	100



KOD	ÜRÜN AÇIKLAMASI	ADET
ET-06641-1	M 3/8 Tombul Ayak Metal 10 cm Krom	100
ET-06642-1	M 3/8 Tombul Ayak Metal 12 cm Krom	100
ET-06643-1	M 3/8 Tombul Ayak Metal 15 cm Krom	100
ET-06641	M8 Tombul Ayak Metal 10 cm Krom	100
ET-06642	M8 Tombul Ayak Metal 12 cm Krom	100
ET-06643	M8 Tombul Ayak Metal 15 cm Krom	100



KOD	ÜRÜN AÇIKLAMASI	ADET
ET-06101	Lüks Nisan Ayak 6 cm Mat Krom	100
ET-06102	Lüks Nisan Ayak 8 cm Mat Krom	100
ET-06103	Lüks Nisan Ayak 10 cm Mat Krom	100
ET-06104	Lüks Nisan Ayak 6 cm Beyaz	100
ET-06441	Lüks Nisan Ayak 8 cm Beyaz	100
ET-06106	Lüks Nisan Ayak 10 cm Beyaz	100

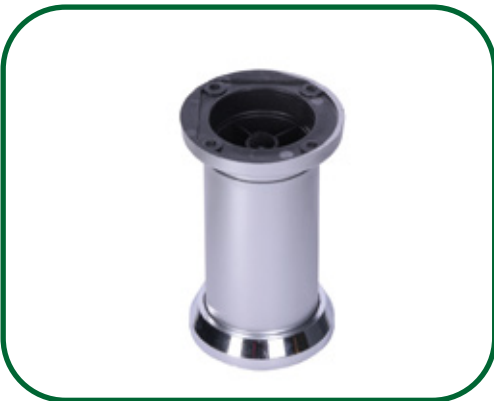

KOD	ÜRÜN AÇIKLAMASI	ADET
ET-04627	Nisan Ayak 5 cm Mat Krom	100
ET-04628	Nisan Ayak 8 cm Mat Krom	100
ET-04563	Nisan Ayak 10 cm Mat Krom	100
ET-05888	Nisan Ayak 12 cm Mat Krom	100
ET-005947	Nisan Ayak 15 cm Mat Krom	100
ET-04627/1	Nisan Ayak 5 cm Siyah	100
ET-04628/1	Nisan Ayak 8 cm Siyah	100
ET-04563/1	Nisan Ayak 10 cm Siyah	100



KOD	ÜRÜN AÇIKLAMASI	ADET
ET-00151	Masa Ayağı 70 cm Krom	4
ET-00153	Masa Ayağı 70 cm Siyah	4
K-145/2	Masa Ayağı 80 cm Krom - Siyah	4
K-145/1	Masa Ayağı 90 cm Krom- Siyah	4
K-145	Masa Ayağı 100 cm Krom- Siyah	4
EK-121	Sehpa Ayağı 40 cm Saten	4
EK-00372	Sehpa Ayağı 40 cm Krom	4



KOD	ÜRÜN AÇIKLAMASI	ADET
ET-04898	Ø42 Metal Baza Ayak 6 cm Krom- Siyah	100
ET-01420	Ø42 Metal Baza Ayak 8 cm Krom- Siyah	100
ET-04876	Ø42 Metal Baza Ayak 10 cm Krom- Siyah	100
ET-04896	Ø42 Metal Baza Ayak 12 cm Krom- Siyah	100
ET-04877	Ø42 Metal Baza Ayak 15 cm Krom- Siyah	100
ET-06633	Ø42 Metal Baza Ayak 17 cm Krom- Siyah	100
ET-04878	Ø42 Metal Baza Ayak 20 cm Krom- Siyah	100



KOD	ÜRÜN AÇIKLAMASI	ADET
ET-09849	Ø60 Metal Baza Ayak 6 cm Krom- Siyah	100
ET-01074	Ø60 Metal Baza Ayak 8 cm Krom- Siyah	100
ET-09850	Ø60 Metal Baza Ayak 10 cm Krom- Siyah	100
EK-212	Ø60 Metal Baza Ayak 12 cm Krom- Siyah	100
K-75	Ø60 Metal Baza Ayak 15 cm Krom- Siyah	100
K-76	Ø60 Metal Baza Ayak 20 cm Krom- Siyah	100
ET-01076	Ø60 Metal Baza Ayak 25 cm Krom- Siyah	100
ET-01077	Ø60 Metal Baza Ayak 30 cm Krom- Siyah	100



KOD	ÜRÜN AÇIKLAMASI	ADET
ET-05485	Katlanır Konsul 30 cm	15
ET-05486	Katlanır Konsul 40 cm	15



KOD	ÜRÜN AÇIKLAMASI	ADET
ET-00020	Tablalı Servis Tekerı Büyük	50
ET-00019	Tablalı Servis Tekerı Küçük	50
ET-00021	Vidalı Servis Tekerı Büyük	50
ET-00022	Vidalı Servis Tekerı Küçük	50

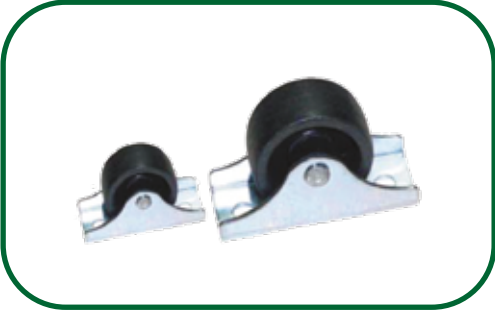

KOD	ÜRÜN AÇIKLAMASI	ADET
ET-00024	Sabit Teker 28 mm	50
ET-03933	Sabit Teker 32 mm	50
ET-00023	Sabit Teker 38 mm	50

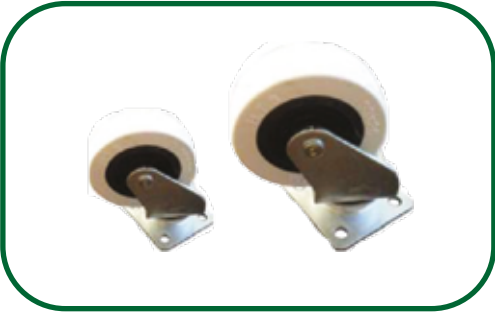

KOD	ÜRÜN AÇIKLAMASI	ADET
ET-01827	Tablalı Bilyalı Teker 50x20	50
ET-05460	Tablalı Bilyalı Teker 75x25	50
ET-01983	Tablalı Bilyalı Teker 28*14	50



KOD	ÜRÜN AÇIKLAMASI	ADET
ET-04257	Tablalı Frenli Gri Teker 50x20	80
ET-05459	Tablalı Frenli Gri Teker 75x25	40

HTS

KOD	ÜRÜN AÇIKLAMASI	ADET
099	Sabit Teker 20 mm	50
101	Sabit Teker 28 mm	50
102	Sabit Teker 32 mm	50
103	Sabit Teker 38 mm	50
104	Sabit Teker 50 mm	50

HTS

KOD	ÜRÜN AÇIKLAMASI	ADET
251	50 x 20 mm Tablalı Teker Gri Eko	50
254	50 x 20 mm Tablalı Frenli Teker Gri	50
321	50 x 20 mm Tablalı Teker Gri	50

HTS

KOD	ÜRÜN AÇIKLAMASI	ADET
405	Vidalı Teker Küçük 40 mm	50
321	Vidalı Teker Küçük 50 mm	50



HTS

KOD	ÜRÜN AÇIKLAMASI	ADET
404	Tablalı Teker Küçük 40 mm	50
401	Tablalı Teker Büyük 50 mm	50



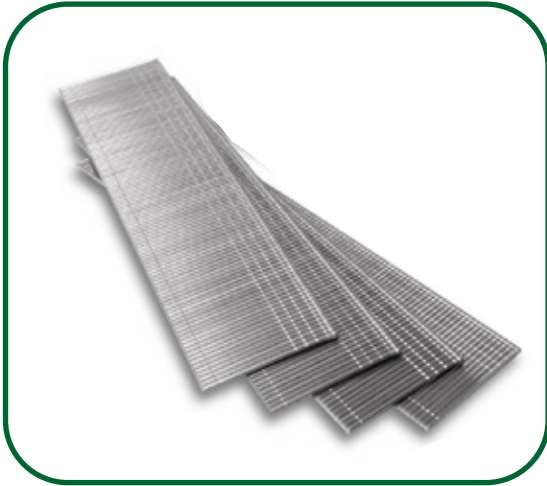

KOD	ÜRÜN AÇIKLAMASI	ADET
ET-00859-2	Zimba Teli 806 Rast	36
ET-00098-2	Zimba Teli 808 Rast	30
ET-00856-2	Zimba Teli 810 Rast	30
ET-00857-2	Zimba Teli 812 Rast	30
ET-00858-2	Zimba Teli 814 Rast	30
ET-03074-2	Zimba Teli 816 Rast	30
ET-00859/1	Zimba Teli 806 Okçu	36
ET-00098/1	Zimba Teli 808 Okçu	30
ET-00856/1	Zimba Teli 810 Okçu	30
ET-00857/1	Zimba Teli 812 Okçu	30
ET-00858/1	Zimba Teli 814 Okçu	30
ET-03074/1	Zimba Teli 816 Okçu	30



KOD	ÜRÜN AÇIKLAMASI	ADET
F-15	Başlı Çivi F15	25
F-20	Başlı Çivi F20	20
F-25	Başlı Çivi F25	20
F-30	Başlı Çivi F30	20
F-40	Başlı Çivi F40	10
F-50	Başlı Çivi F50	10
ET-067	90 Serisi Zimba Teli 20-25-30-35-40	10
ET-065	92 Serisi Zimba Teli 20-25-30-35-40	10
ET-065	100 Serisi Zimba Teli 20-25-30-35-40-50	10



KOD	ÜRÜN AÇIKLAMASI	ADET
ET-04200	Rötuş Kalemi Beyaz	12
ET-04702	Rötuş Kalemi Ceviz	12
ET-04281	Rötuş Kalemi Krem	12
ET-04201	Rötuş Kalemi Siyah	12
ET-05472	Rötuş Kalemi Maun	12
ET-05471	Rötuş Kalemi Meşe	12
ET-05473	Rötuş Kalemi Wenge	12
ET-05130	Rötuş Kalemi 3'lü (Açık-Orta-Koyu Kahve)	12

KOD	ÜRÜN AÇIKLAMASI	ADET
	Pacific Yapışma Tapa	50

*Renkler ve Kodlara Sonraki Sayfadan Ulaşabilirsiniz.



KOD	ÜRÜN AÇIKLAMASI	ADET
ET-00194-1	Silikon Stoper	25
PC-2861	Silikon Cam Altlığı 22 mm	25
ET-01892	Silikon Cam Altlığı 18 mm	25



KOD	ÜRÜN AÇIKLAMASI	ADET
PC-6020	Yapışma Keçe 20 x 20	25
PC-6025	Yapışma Keçe 25 x 25	25
PC-6030	Yapışma Keçe 30 x 30	25
PC-6035	Yapışma Keçe 35 x 35	25
PC-6055	Yapışma Keçe 35 x 55	25
PC-6040	Yapışma Keçe 40 x 40	25
PC-6050	Yapışma Keçe 50 x 50	25
PC-6001	Yapışma Keçe Karma	25
PC-6115	Yapışma Keçe Ø15	25
PC-6118	Yapışma Keçe Ø18	25
PC-6120	Yapışma Keçe Ø20	25
PC-6124	Yapışma Keçe Ø24	25
PC-6140	Yapışma Keçe Ø40	25
PC-6150	Yapışma Keçe Ø50	25
PC-6155	Yapışma Keçe Ø55	25

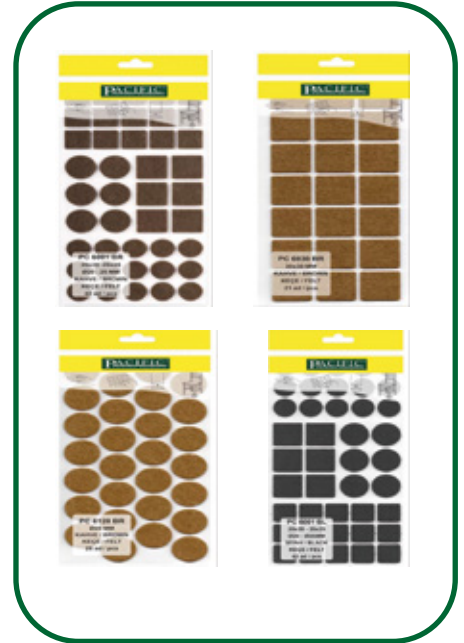

KOD	ÜRÜN AÇIKLAMASI	ADET
ET-00133/2	Vida Kapağı 13 mm Krom - Saten	250
ET-00133/4	Vida Kapağı 15 mm Krom - Saten	250
ET-00133/6	Vida Kapağı 20 mm Krom - Saten	250
ET-00133	Vida Kapağı 13 mm Siyah- Altın	250
ET-00133-9	Vida Kapağı 15 mm Siyah- Altın	250
ET-0133-8	Vida Kapağı 20 mm Siyah- Altın	250



PARLAK RENKLER - HIGH GLOSS COLOURS

NEW PC 2365 PARLAK ANTRASİT	NEW PC 2385 PARLAK CAPPUCINO	PC 2305 PARLAK BEYAZ	PC 2306 PARLAK YAĞMUR BEYAZ
PC 2310 PARLAK KREM	PC 2315 PARLAK KIRMIZI	PC 2316 PARLAK YAĞMUR KIRMIZI	PC 2320 PARLAK BORDO
PC 2325 PARLAK SİYAH	PC 2326 PARLAK YAĞMUR SİYAH	PC 2330 PARLAK ABANOZ	PC 2335 PARLAK METALİK KARAAĞAÇ
PC 2340 PARLAK VENGE	PC 2345 PARLAK ZEYTİN	PC 2350 PARLAK CEVİZ	PC 2355 PARLAK MİLANO CEVİZ
PC 2360 PARLAK BAMBU	PC 2370 PARLAK MÜRDÜM	PC 2375 PARLAK METALİK EKRU	

DÜZ RENKLER - SOLID COLOURS

NEW PC 2511 LAKE SİYAH	PC 2500 BEYAZ	PC 2501 LAKE BEYAZ	PC 2502 SÜT BEYAZ
PC 2505 BEJ	PC 2507 KREM	PC 2510 SİYAH	PC 2530 SARI
PC 2535 PORTAKAL	PC 2540 METALİK GRİ	PC 2545 GRİ	PC 2546 ANTRASİT
PC 2555 SU YEŞİLİ	PC 2560 MAVİ	PC 2565 LİLA	PC 2570 KIRMIZI
PC 2626 LATTE	PC 2635 AYTAŞI		

PC 2135 HUŞ	PC 2140 DOĞAL HUŞ	PC 2145 KIRAZ	PC 2146 AÇIK KIRAZ
PC 2155 ARMUT	PC 2160 İTALYAN CEVİZ	PC 2165 YENİ CEVİZ	PC 2170 KOYU CEVİZ
PC 2171 VENEZIA CEVİZ	PC 2175 KOYU ÇAM	PC 2180 VENGE	PC 2185 MAUN
PC 2195 TİK	PC 2200 ZEYTİN	PC 2205 KOYU ZEBRANO	PC 2206 ZEBRANO
PC 2210 BEYAZ AKÇAAĞAÇ	PC 2230 BAMBU	PC 2605 CORDOBA	PC 2610 TREND GRİ
PC 2615 TREND BEJ	PC 2620 KOTON VİZON	PC 2625 KOTON LATTE	PC 2630 LADİN
NEW PC 2121 HALIFAX MEŞE	NEW PC 2122 NEBRASKA MEŞE	NEW PC 2123 SÜT MEŞE	NEW PC 2126 SONOMA MEŞE
NEW PC 2172 MILAS CEVİZ	NEW PC 2173 CEVİZ	NEW PC 2176 BEYAZ ÇAM	NEW PC 2190 ABANOZ
NEW PC 2585 AÇIK ANTİK	NEW PC 2590 ANTİK KAHVE	NEW PC 2591 ANTİK BEYAZ	NEW PC 2600 ANTİK ÇAM
NEW PC 2640 OZIGO	NEW PC 2645 SALERNO	NEW PC 2650 LAREX	NEW PC 2655 SOSNA NORWESKA
NEW PC 2660 AMALFI	PC 2100 KAYIN	PC 2110 AKÇAAĞAÇ	PC 2115 BANU
PC 2120 MEŞE	PC 2125 EĞİRDİR MEŞE	PC 2131 NATUREL MEŞE	PC 2132 CHAMONIX MEŞE



KOD	ÜRÜN AÇIKLAMASI	ADET
ET-05480	Çivi Raf Pimi Büyük Beyaz	1000



KOD	ÜRÜN AÇIKLAMASI	ADET
ET-00116	Metal Başlı Raf Pimi	1000
	Beyaz - Şeffaf - Siyah - Kahverengi - Krem - Gri	



KOD	ÜRÜN AÇIKLAMASI	ADET
ET-03222	Çivili Poligrit Renkli	1000
ET-03611	Çivili Poligrit Şeffaf	1000



KOD	ÜRÜN AÇIKLAMASI	ADET
ET-00898	Yuvarlak Tas Kulp	200
	Siyah - Krom - Beyaz - Gri	

KOD	ÜRÜN AÇIKLAMASI	ADET
ET-01431	Yatak Baza Pistonu 450N-650N-750N-1000N-1200N	20
ET-00571	Baza Kulbu	50
ET-0081	Baza Makası Sağ	20
ET-0081/1	Baza Makası Sol	20



KOD	ÜRÜN AÇIKLAMASI	ADET
ET-05080	Kablo Kanalı Beyaz-Krem-Kahve-Siyah- Gri	50
ET-00368	Ayakkabı Kasnağı AYDER	65



KOD	ÜRÜN AÇIKLAMASI	ADET
ET-01083	Mıknatıslı Çıtçıt Yaylı Beyaz	50
ET-01084	Mıknatıslı Çıtçıt Yaylı Kahve	50
ET-01081	Mıknatıslı Çıtçıt Yaysız Beyaz	50
ET-01082	Mıknatıslı Çıtçıt Yaysız Kahve	50
ET-04271	Mıknatıslı Çıtçıt Yaysız Siyah	50
ET-00122	Plastik Çıtçıt Beyaz-Kahve	250



KOD	ÜRÜN AÇIKLAMASI	ADET
970188800	Kapak İtici (Bas-aç) Metal STD	100
970187800	Kapak İtici (Bas-aç) Gri STD	100
970186800	Kapak İtici (Bas-aç) Beyaz STD	100





KOD	ÜRÜN AÇIKLAMASI	ADET
ET-06768	Streç Film 17 Micron 170 Mt 1600 Gr	6
ET-04924	Streç Film 17 Micron 190 Mt 1700 Gr	6
ET-05522	Streç Film 17 Micron 270 Mt 2350 Gr	6



KOD	ÜRÜN AÇIKLAMASI	ADET
ET-01438/1	Sünger Zımpara 120 Kum	25 mt
ET-01438/2	Sünger Zımpara 150 Kum	25 mt
ET-01438	Sünger Zımpara 180 Kum	25 mt
ET-01438/3	Sünger Zımpara 220 Kum	25 mt
ET-01438/7	Sünger Zımpara 240 Kum	25 mt
ET-01438/4	Sünger Zımpara 280 Kum	25 mt
ET-01438/5	Sünger Zımpara 320 Kum	25 mt
ET-01438/6	Sünger Zımpara 400 Kum	25 mt



KOD	ÜRÜN AÇIKLAMASI	ADET
9010	Bormawachs Tüp Tamir Macunu	12
Beyaz - Parlak Beyaz - Kayın - Meşe - Siyah - Gri - Gürgen - Wenge - Tik - Ceviz - Kiraz - Maun - Naturel - Çam - Antrasit- Koyu Ceviz- Açık Ceviz - Açık Meşe- Kumtaşı - Aytaşı - Açık Çam		



KOD	ÜRÜN AÇIKLAMASI	ADET
ET-01018	Tamir Macunu	30
Beyaz - Kayın - Meşe - Akça Ağaç - Siyah - Kahverengi - Krem - Gri - Gürgen - Wenge - Tik - Kelebek - Ceviz - Fındık - Kiraz - Huş - Maun - Naturel - Dişbudak - Çam - Antrasit - Armut		

KOD	ÜRÜN AÇIKLAMASI	ADET
ET-06057	Mutfak Askı Elemanı VENT	250
V201/2	Mutfak Askı Elemanı VOLKAN	200
1006	Mutfak Askı Elemanı METALİ	250
ET-01569	Mutfak Askı Elemanı FLORE	250



KOD	ÜRÜN AÇIKLAMASI	ADET
ET-01391	Plastik Beyaz Dübel 6 mm	1000
ET-02084	Plastik Beyaz Dübel 7 mm	1000
ET-01392	Plastik Beyaz Dübel 8 mm	1000
ET-01393	Plastik Beyaz Dübel 10 mm	500
ET-05082	Roket Sarı Dübel 8 mm Made	500
ET-05083	Roket Sarı Dübel 10 mm Made	500
ET-05568	Premium Roket Kırmızı Dübel 8 mm Made	200
ET-00416	Tuğla Boşluk Dübeli Gri 8 mm	500
ET-00408	Tuğla Boşluk Dübeli Gri 10 mm	500
ET-06394	Tuğla Boşluk Dübeli Gri 12 mm	500

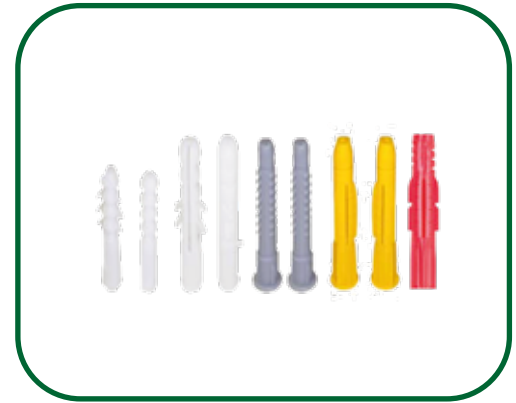

KOD	ÜRÜN AÇIKLAMASI	ADET
ET-00130	Plastik Açık Köşe Bağlantı	500
ET-00412	Plastik Baza Pabucu	500



KOD	ÜRÜN AÇIKLAMASI	ADET
ET-052/08	Beşik Sallama Aparatı	20
ET-00025	Sofra Ayağı	100



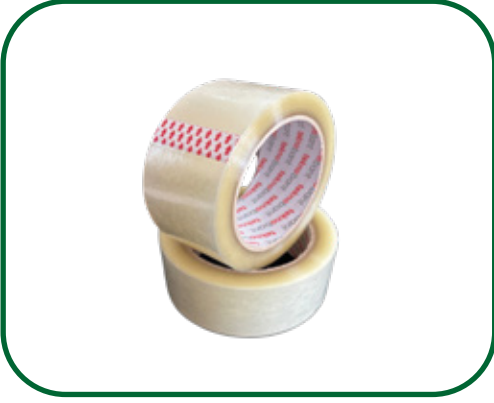

KOD	ÜRÜN AÇIKLAMASI	ADET
ET-06859	Koli Bandı Akriolik 45mm x 100 mt	84
ET-06871	Koli Bandı Hotmelt 45mm x 100 mt	84

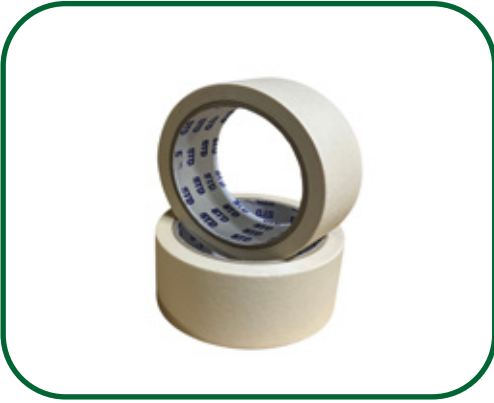

KOD	ÜRÜN AÇIKLAMASI	ADET
970419800	Maskeleme Bandı 18 mm x 25 mt Hotmelt	96
970420800	Maskeleme Bandı 24 mm x 25 mt Hotmelt	72
972421800	Maskeleme Bandı 36 mm x 25 mt Hotmelt	48
972422800	Maskeleme Bandı 48 mm x 25 mt Hotmelt	36



KOD	ÜRÜN AÇIKLAMASI	ADET
976837800	İş Ayakkabası Alto S1 Süt	2
37- 38- 39- 40 -41 -42 -43 -44 -45		



KOD	ÜRÜN AÇIKLAMASI	ADET
974642800	STD Pro Pamuk Nitril Eldiven	288
965891800	STD Zebra Nitril Eldiven Kırmızı	288

MADE

KOD	ÜRÜN AÇIKLAMASI	ADET
TKSML	Made 3'lü Takım Çantası S-M-L	1



SUPER-BAG

KOD	ÜRÜN AÇIKLAMASI	ADET
ASR-	Mega Organizer	10
No: 22 - No: 23 - No: 24		



SUPER-BAG

KOD	ÜRÜN AÇIKLAMASI	ADET
ASR-	Metal Takım Çantası	1
16'lık - 19'luk - 22'lik		



SUPER-BAG

KOD	ÜRÜN AÇIKLAMASI	ADET
ASR-	Slim Mobil Tekerlekli Çanta	1
No: 18		





DIN 7505 SUNTA VİDALARI

kod ms	kod ith	ölçü	kutu ad.	koli ad.
28530	10209	3x13 mm	1.000	36.000
28531	10210	3x16 mm	1.000	36.000
28532	10211	3x20 mm	1.000	27.000
28533	10212	3x25 mm	1.000	18.000
28534	10213	3x30 mm	1.000	18.000
28535	10214	3x35 mm	1.000	12.000
28536	10215	3x40 mm	1.000	12.000
56424	10247	3,5x13 mm	1.000	36.000
28538	10248	3,5x16 mm	1.000	27.000
28539	10249	3,5x18 mm	1.000	27.000
28540	10250	3,5x20 mm	1.000	18.000
28541	10251	3,5x25 mm	1.000	18.000
28542	10252	3,5x30 mm	1.000	12.000
28543	10253	3,5x35 mm	1.000	12.000
28544	10254	3,5x40 mm	500	6.000
41421	10255	3,5x45 mm	500	6.000
28546	10256	3,5x50 mm	500	6.000
28547	10216	4x16 mm	1.000	18.000
28548	25008	4x18 mm	1.000	18.000
28549	10217	4x20 mm	1.000	18.000
28550	10218	4x25 mm	500	13.500
28551	10219	4x30 mm	500	9.000
28552	10220	4x35 mm	500	9.000
28553	10221	4x40 mm	500	6.000
28554	10222	4x45 mm	500	6.000
28555	10223	4x50 mm	500	4.500
28556	10224	4x60 mm	200	2.400
28557	10225	4x70 mm	200	1.800



DIN 7505 SUNTA VİDALARI

kod ms	kod ith	ölçü	kutu ad.	koli ad.
28558	10257	4,5x25 mm	500	9.000
28559	10258	4,5x30 mm	500	9.000
57557	10259	4,5x35 mm	200	5.400
28561	10260	4,5x40 mm	200	3.600
28562	10261	4,5x45 mm	200	3.600
28563	10262	4,5x50 mm	200	3.600
28564	10263	4,5x60 mm	200	2.400
28565	10226	5x30 mm	200	5.400
28566	10227	5x35 mm	200	5.400
28567	10228	5x40 mm	200	3.600
28568	10229	5x45 mm	200	3.600
28569	10230	5x50 mm	200	3.600
28570	10231	5x60 mm	200	2.400
28571	10232	5x70 mm	200	1.800
28572	10233	5x80 mm	200	2.400
28573	10234	5x90 mm	100	1.200
28574	10235	5x100 mm	100	1.200
28576	10240	6x50 mm	200	2.400
28577	10241	6x60 mm	200	1.800
40549	10242	6x70 mm	100	1.200
28579	10243	6x80 mm	100	1.200
28580	10244	6x90 mm	100	1.200
28581	10245	6x100 mm	100	1.200
28582	10246	6x120 mm	50	600
28583	16168	6x140 mm	50	600
28584	16169	6x150 mm	50	600

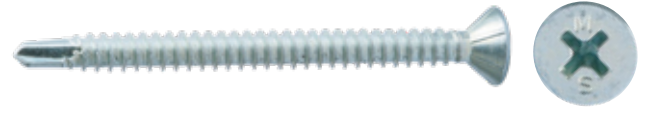

DIN 7504N YSB MATKAP UÇLU VİDALAR

kod ms	kod ith.	ölçü	kutu ad.	koli ad.
28661	09804	3,9x13 mm	3.500	14.000
28662	09805	3,9x16 mm	2.500	15.000
28663	09806	3,9x19 mm	2.000	12.000
28664	09807	3,9x22 mm	2.000	12.000
28665	09808	3,9x25 mm	1.500	9.000
28667	09810	3,9x32 mm	1.250	7.500
28668	09811	3,9x38 mm	750	6.750
28669	09813	4,2x13 mm	2.500	15.000
28670	09814	4,2x16 mm	2.500	10.000
28671	09815	4,2x19 mm	1.750	10.500
28672	09816	4,2x22 mm	1.500	9.000
28673	09817	4,2x25 mm	1.500	9.000
28675	09819	4,2x32 mm	1.000	6.000
28676	09820	4,2x38 mm	750	6.750
28677	09821	4,2x45 mm	500	4.500
28678	09822	4,2x50 mm	500	4.500
28679	09823	4,8x13 mm	2.000	8.000
28680	09824	4,8x16 mm	1.500	9.000
28681	09825	4,8x19 mm	1.500	6.000
28682	09826	4,8x22 mm	1.250	7.500
28683	09827	4,8x25 mm	1.000	6.000
28685	09829	4,8x32 mm	750	4.500
28686	09830	4,8x38 mm	600	3.600
28687	09831	4,8x45 mm	400	3.600
28688	09832	4,8x50 mm	400	3.600
28689	09833	4,8x60 mm	300	2.700
28690	09834	4,8x70 mm	200	1.800
28691	09835	4,8x80 mm	150	1.350
28692	09836	4,8x90 mm	125	1.125
28693	09837	4,8x100 mm	125	1.350

DIN 7504P YHB MATKAP UÇLU VİDALAR

kod ms	kod ith.	ölçü	kutu ad.	koli ad.
28620	41790	3,9x13 mm	5.000	20.000
28621	41536	3,9x16 mm	3.500	21.000
53669	41537	3,9x19 mm CNC	2.500	15.000
54853		3,9x19 mm ^{uzun} CNC	2.500	15.000
28623	41710	3,9x22 mm	2.000	12.000
28624	41538	3,9x25 mm	1.750	10.500
28626	41539	3,9x32 mm	1.250	11.250
28627	41712	3,9x38 mm	750	6.750
28628	50771	4,2x13 mm	4.000	16.000
28629	50772	4,2x16 mm	3.000	12.000
28630	35579	4,2x19 mm	2.500	15.000
28631	35580	4,2x22 mm	2.000	12.000
28632	36323	4,2x25 mm	1.500	9.000
28634	35765	4,2x32 mm	1.000	9.000
28635	32788	4,2x38 mm	750	6.750
28636	32789	4,2x45 mm	600	5.400
28637	50773	4,2x50 mm	500	4.500
28639	15456	4,2x60 mm	400	3.600
28641	50774	4,8x16 mm	2.500	10.000
28642	50775	4,8x19 mm	2.000	8.000
28643	50776	4,8x22 mm	1.500	9.000
28644	50922	4,8x25 mm	1.250	7.500
28646	28968	4,8x32 mm	1.000	6.000
28647	32643	4,8x38 mm	750	4.500
28648	50777	4,8x45 mm	500	4.500
28649	32790	4,8x50 mm	500	4.500
28650	32390	4,8x60 mm	300	2.700
28651	35766	4,8x70 mm	250	2.250
28652	35581	4,8x80 mm	150	1.350
28653	50923	4,8x90 mm	150	1.350
28654	50924	4,8x100 mm	150	900



MATKAP UÇLU ALÇI LEVHAVIDALARI

kod ith	ölçü	kutu ad.	koli ad.
43812	3,5x25 mm	1.000	6.000
43813	3,5x35 mm	1.000	4.000
43814	3,5x45 mm	1.000	3.000



SIK DİŞLİ ALÇI LEVHAVIDALARI

kod ith	ölçü	kutu ad.	koli ad.
43809	3,5x25 mm	1.000	8.000
43810	3,5x35 mm	1.000	6.000
43811	3,5x45 mm	1.000	4.000



ŞERİTLİ ALÇI LEVHAVIDALARI

kod ith	ölçü	kutu ad.	koli ad.
51054	3,5x35 SIK DİŞ	1.000	10.000
42654	3,5x25 MU	1.000	10.000
27782	3,5x35 MU	1.000	10.000
42749	3,5x45 MU	1.000	10.000



SEYREK DİŞLİ ALÇI LEVHAVIDALARI

kod ith	ölçü	kutu ad.	koli ad.
43815	3,5x25 mm	1.000	8.000
43816	3,5x35 mm	1.000	6.000
43817	3,5x45 mm	1.000	4.000



POLIÜRETAN PANEL VİDALARI

kod ms	kod ith	ölçü	koli ad.
28720	09838	5,5x66 6 mm Delme Kap.	1.200
28721	09839	5,5x76 6 mm Delme Kap.	800
28722	09840	5,5x90 6 mm Delme Kap.	900
28723	09841	5,5x105 6 mm Delme Kap.	675
28724	09842	5,5x120 6 mm Delme Kap.	400
28725	09843	5,5x130 6 mm Delme Kap.	300
	09844	5,5x32 12 mm Delme Kap.	1.600
	09845	5,5x50 12 mm Delme Kap.	1.200
	09846	5,5x60 12 mm Delme Kap.	800
	09847	5,5x66 12 mm Delme Kap.	800
	09848	5,5x76 12 mm Delme Kap.	600
	09849	5,5x90 12 mm Delme Kap.	400
	09850	5,5x105 12 mm Delme Kap.	450
	09851	5,5x120 12 mm Delme Kap.	300
	09852	5,5x135 12 mm Delme Kap.	300



PUL BAŞLI MATKAP UÇLU VİDA (RYSB)

kod ms	kod ith	ölçü	kutu ad.	koli ad.
28700	09680	3,9x13	2.500	15.000
28701	09681	3,9x16	2.000	12.000
28702	09682	3,9x19	1.500	9.000
28703	09683	3,9x25	1.500	9.000
28704	09684	4,2x16	1.750	7.000
28705	09685	4,2x19	1.500	9.000



MDF VİDASI

kod ms	kod	ölçü	kutu ad.	koli ad.
54247	45795	3,5x50 mm	200	7.200
54248	45796	4x50 mm	200	7.200



ARKALIK VİDASI

kod	ölçü	koli ad.
32969	3,5x25 Arkalık Vidası	8.000



BULDEKS VİDALAR

kod ms	kod ith	ölçü	koli ad.
28520		7,5x60 mm	2.000
28521		7,5x80 mm	1.500
28522		7,5x100 mm	1.000
28523		7,5x120 mm	1.000
28524		7,5x150 mm	750
28525	29467	7,5x180 mm	750
28526	36713	7,5x200 mm	500



AHŞAPÇATI VİDALARI

kod	ölçü	koli ad.
28695	6,3x50	1.200
28696	6,3x75	600
28697	6,3x105	450
28698	6,3x125	300
26468	6,3x135	200

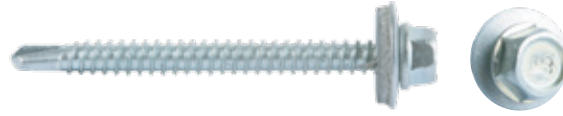

7504K MATKAP UÇLU ÇATI VİDALARI

kod ms	kod ith	ölçü	kutu ad.	koli ad.
	09583	4,2x16 mm		3.500
	09584	4,2x19 mm		3.000
28602	09585	4,8x16 mm	500	3.000
28603	09586	4,8x19 mm	500	4.500
28604	09587	4,8x25 mm	400	3.600
28605	09588	4,8x32 mm	400	3.600
28606	09589	5,5x25 mm	400	3.600
28607	09590	5,5x32 mm	350	2.100
28608	09591	5,5x38 mm	250	2.250
28609	09592	5,5x50 mm	200	1.800
28610	09593	5,5x60 mm	150	1.350
28611	09594	6,3x25 mm	250	2.000
28612	09595	6,3x32 mm	250	1.500
28613	09596	6,3x38 mm	225	1.350
28614	09597	6,3x50 mm	175	1.050
40548	09598	6,3x60 mm	150	1.350

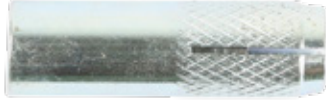

ÇAKMA DÜBEL

kod	ürün adı	koli ad.
20680	M 6 Çakma Dübel Beyaz	4.000
20681	M 8 Çakma Dübel Beyaz	2.000
20682	M 10 Çakma Dübel Beyaz	1.000
20683	M 12 Çakma Dübel Beyaz	500
20684	M 14 Çakma Dübel Beyaz	350
20685	M 16 Çakma Dübel Beyaz	250
20686	M 20 Çakma Dübel Beyaz	100



ÇEKME DÜBEL

kod	ürün adı	koli ad.
58149	6x65 Çekme Dübel	1000
03960	8x75 Çekme Dübel	500
03961	10x85 Çekme Dübel	250
03962	12x90 Çekme Dübel	200
03963	14x110 Çekme Dübel	100
03964	16x120 Çekme Dübel	80



S TİPİ DÜBEL

kod	ürün adı	koli ad.
19595	M 8 S Tipi Dübel	1200
22482	M 10 S Tipi Dübel	720
32049	M 12 S Tipi Dübel	420



GÖMLEKLİ DÜBEL

kod	ürün adı	koli ad.
14704	M 6x45 Gömleklİ Dübel	1.500
19609	M 6x65 Gömleklİ Dübel	1000
10959	M 8x55 Gömleklİ Dübel	800
12504	M 8x75 Gömleklİ Dübel	500
11817	M 10x70 Gömleklİ Dübel	400
11771	M 10x85 Gömleklİ Dübel	250
14192	M 10x110 Gömleklİ Dübel	200
22889	M 12x90 Gömleklİ Dübel	200
12505	M 12x110 Gömleklİ Dübel	150

550W 10MM DARBESİZ MATKAP

DWD014S

Giriş Gücü	550W
Mandren Kapasitesi	10 mm
Yüksüz Hızı	0-2800 dev/dak.
Maksimum Tork	7.9 Nm
Maksimum Delme Kapasitesi [Ahşap]	25 mm
Maksimum Delme Kapasitesi [Metal]	10 mm
Mil Bağlantısı	1/2" x 20 U.N.F
Ağırlık	1.34 kg
Uzunluk x Yükseklik	225 x 170 mm



701W 10MM DARBESİZ MATKAP

DWD112S

Giriş Gücü	701W
Mandren Kapasitesi	10 mm
Yüksüz Hızı	0-2500 dev/dak.
Maksimum Tork	10.9 Nm
Maksimum Delme Kapasitesi [Ahşap]	25 mm
Maksimum Delme Kapasitesi [Metal]	10 mm
Mil Bağlantısı	1/2" x 20 U.N.F
Ağırlık	1.8 kg
Uzunluk x Yükseklik	230 x 190 mm



701W 13MM DARBELİ MATKAP

DWD024

Giriş Gücü	750W
Mandren Kapasitesi	13 mm
Yüksüz Hızı	0-2800 dev/dak.
Darbe Oranı	47600 dar/dak.
Maksimum Tork	8.6 Nm
Maksimum Delme Kapasitesi [Ahşap]	25 mm
Maksimum Delme Kapasitesi [Metal]	13 mm
Maksimum Delme Kapasitesi [Beton]	16 mm
Ağırlık	1.82 kg
Uzunluk x Yükseklik	255 x 180 mm



18V 1.5AH LI-ION ÇİFT AKÜLÜ DARBESİZ MATKAP

DCD771S2

Akü Voltajı	18V
Akü Tipi	Li-ion
Akü Kapasitesi	1.5 Ah
Maksimum Tork (Sert)	42 Nm
Maksimum Tork (Yumuşak)	24 Nm
Yüksüz Hızı	0-450/1500 dev/dak.
Mandren Kapasitesi	1.5-13 mm
Maksimum Delme Kapasitesi [Ahşap / Metal]	30/13 mm
Ağırlık	1.65 kg
Uzunluk x Yükseklik	219 x 191 mm



18V 1.5AH LI-ION KÖMÜRSÜZ ÇİFT AKÜLÜ DARBESİZ MATKAP

DCD777S2T

Akü Voltajı	18V
Akü Tipi	Li-ion
Akü Kapasitesi	1.5 Ah
Maksimum Tork (Sert)	65 Nm
Maksimum Tork (Yumuşak)	26 Nm
Yüksüz Hızı	0-500/1750 dev/dak.
Mandren Kapasitesi	1.5-13 mm
Maksimum Delme Kapasitesi [Ahşap / Metal]	30/13 mm
Ağırlık	1.5 kg
Uzunluk x Yükseklik	192 x 198 mm



18V 2.0AH LI-ION KOMPAKT KÖMÜRSÜZ ÇİFT AKÜLÜ DARBESİZ MATKAP

DCD708D2T

Akü Voltajı	18V
Akü Tipi	Li-ion
Akü Kapasitesi	2.0 Ah
Maksimum Tork (Sert)	65 Nm
Maksimum Tork (Yumuşak)	26 Nm
Yüksüz Hızı	0-450/1650 dev/dak.
Mandren Kapasitesi	1.5-13 mm
Maksimum Delme Kapasitesi [Ahşap / Metal]	35/13 mm
Ağırlık	1.45 kg
Uzunluk x Yükseklik	160 x 198 mm



18V 1.5AH LI-ION ÇİFT AKÜLÜ DARBELİ MATKAP

SCH20S2K

Güç	18 V
Akü Kapasitesi	1.5 Ah
Maks. Tork Gücü	45 Nm
Yüksüz Hızı	0-350/1500 dev/dak
Darbe Hızı	0-25500 dar/dak
Mandren Kapasitesi	13 mm
Maks. Delim Kapasitesi	1/4" (6.35mm)
Ahşap	35 mm
Metal	13 mm
Duvar	13 mm
Koli Adedi	4
Ağırlık	1.66 kg

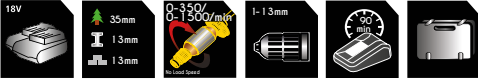

18V 1.5AH V20 LİTYUM ÇİFT AKÜLÜ DARBELİ MATKAP

SCD711C2K

Akü Voltajı	18V
Akü Tipi	V20 Li-ion
Akü Kapasitesi	1.5 Ah
Maksimum Tork	50 Nm
Yüksüz Hızı	0 - 400 / 1.500 dev/dak.
Mandren Kapasitesi	13 mm
Maks. Delme Kapasitesi (Ahşap)	35 mm
Maks. Delme Kapasitesi (Metal)	13 mm
Koli Adedi	3
Ağırlık	1.3 kg (batarya hariç)

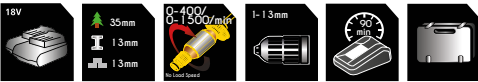

V20
LITHIUM ION

18V 2.0AH LI-ION ÇİFT AKÜLÜ DARBESİZ MATKAP

SCD201D2K

Güç	18 V
Akü Kapasitesi	2.0 Ah
Maks. Tork Gücü	45 Nm
Yüksüz Hızı	0-350/1500 dev/dak
Mandren Kapasitesi	13 mm
Maks. Delme Kapasitesi	13 mm
Ahşap	35 mm
Metal	13 mm
Koli Adedi	4
Ağırlık	1.6 kg

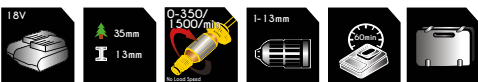

280W 93X230MM T İTREŞİMLİ ZİMPARA MAKİNESİ

SS28

Giriş Gücü	280 W
Yüksüz Hızı	14000 tit/dak
Titreşim Çapı	2 mm
Kağıt Ölçüsü	93x230 mm
Taban Ölçüsü	91x185 mm
Koli Adedi	8
Ağırlık	1.5 kg

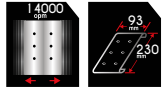

300W 125MM EKSANTRİK ZİMPARA MAKİNESİ

SS30

Giriş Gücü	300 W
Yüksüz Hızı	0-13000 tit/dak
Titreşim Çapı	2 mm
Kağıt Ölçüsü	125 mm
Taban Ölçüsü	125 mm
Koli Adedi	8
Ağırlık	1.4 kg

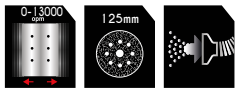

2000W SICAK HAVA TABANCASI

STXH2000

Giriş Gücü	2000 W
Çalışma Sıcaklığı	50-450 / 90-600 °C
Hava Akışı	300/500 l/dak
Koli Adedi	5
Ağırlık	0.8 kg

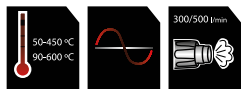

600W 75MM DEKUPAJ TESTERE

SJ60K

Giriş Gücü	600 W
Yüksüz Hızı	500-3000 dev/dak
Testere, Strok Uzunluğu	19 mm
Açı Kapasitesi	45°
Pandül Hareketi	Evet
Maks. Kesme Kapasitesi	8
Ahşap	75 mm
Metal	6 mm
Alüminyum	10 mm
Koli Adedi	6
Ağırlık	1.9 kg

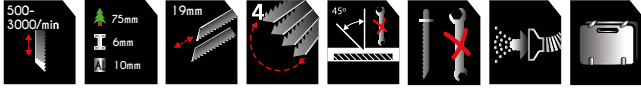

1650W 254MM GÖNYE TESTERE

SM16

Giriş Gücü	1650W
Yüksüz Hızı	4800 dev/dak.
Bıçak Kalınlığı	2.8 mm
Bıçak Çapı	254 X 30 mm
Gönye Kapasitesi (sağ/sol)	52°/47°
Eğim Kapasitesi (sağ/sol)	0°/45°
Koli Adedi	1
Ağırlık	10.5 kg

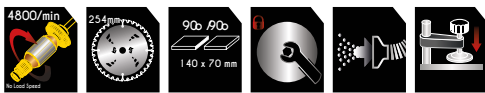

1600W 190MM DAİRE TESTERE

SC16

Giriş Gücü	1600 W
Yüksüz Hızı	5500 dev/dak
Testere Çapı	190 mm
Testere Delik Çapı	20/30 mm
Açı Kapasitesi	45°
Maks. Kesme Kapasitesi 90°	65 mm
Maks. Kesme Kapasitesi 45°	50 mm
Koli Adedi	2
Ağırlık	3.9 kg





KOD	ÜRÜN AÇIKLAMASI	ADET
E1171	Amasra Kulp Krom - Siyah - İnox	50
128-160 mm - 192-224 mm		



KOD	ÜRÜN AÇIKLAMASI	ADET
E3011	Gölcük Kulp Krom - Siyah - İnox	50
96-128 mm - 160-192 mm - 224 256 mm		



KOD	ÜRÜN AÇIKLAMASI	ADET
E2053	Tombik Kulp Krom - Siyah - İnox	50
96-128-160-192-224-320 mm		



KOD	ÜRÜN AÇIKLAMASI	ADET
E1071	Geniş Kemer Kulp Siyah - Krom - Altın - Beyaz	50
96-128-160-192-224 mm		

KOD	ÜRÜN AÇIKLAMASI	ADET
ET-06298	Yıldız Kulp Siyah - Krom - Altın - Beyaz	50
96-128-160-192-224 mm		



KOD	ÜRÜN AÇIKLAMASI	ADET
V3305	Collet Kulp Siyah - Krom - Altın - Beyaz	50
96-128-160-192-224 mm		



KOD	ÜRÜN AÇIKLAMASI	ADET
E1072	Şahin Kulp Krom- Siyah - İnox	50
E1087	Eko Şahin Kulp Krom- Siyah - İnox	50
E1080	Boş Şahin Kulp Krom- Siyah - İnox	50
128-160-192-224 mm		



KOD	ÜRÜN AÇIKLAMASI	ADET
E1501	Dar L Kulp Krom- Siyah - İnox	100
96-128-160-192-224 mm		





KOD	ÜRÜN AÇIKLAMASI	ADET
E1134	Ege Kulp 12 mm Krom - Siyah - İnox	50
E1135	Ege Kulp 15 mm Krom - Siyah - İnox	50
96-128 mm - 160-192 mm - 224 256 mm		



KOD	ÜRÜN AÇIKLAMASI	ADET
E1099	Boğaziçi Kulp Krom - Siyah - İnox	50
128-160-192-224- 320 mm		



KOD	ÜRÜN AÇIKLAMASI	ADET
E1108	Akasya Kulp Krom - Siyah - İnox	50
128-160-192-224-320 mm		



KOD	ÜRÜN AÇIKLAMASI	ADET
E1073	Kumru Kulp Krom - Siyah - İnox	50
128-160-192-224 mm		



KOD	ÜRÜN AÇIKLAMASI	ADET
3209	Art Kulp 160 mm - 224 mm	50
Siyah - Krom - Antik Sarı - Antik Bakır - Altın - Mat Altın - Füme		

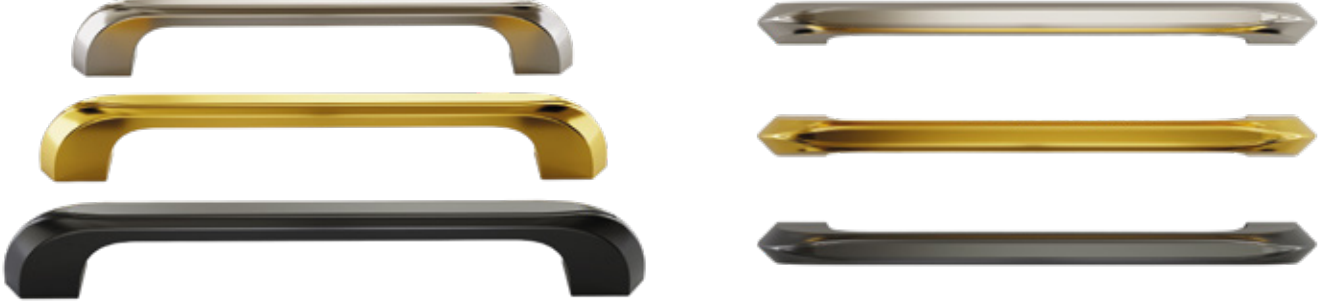

KOD	ÜRÜN AÇIKLAMASI	ADET
3201	Lion Kulp 160 mm - 224 mm	50
Siyah - Krom - Antik Sarı - Antik Bakır - Altın - Mat Altın - Füme		



KOD	ÜRÜN AÇIKLAMASI	ADET
3206	Parrot Kulp 160 mm - 224 mm	50
Siyah - Krom - Antik Sarı - Antik Bakır - Altın - Mat Altın - Füme		



KOD	ÜRÜN AÇIKLAMASI	ADET
3207	Saray Kulp 160 mm - 224 mm	50
Siyah - Krom - Antik Sarı - Antik Bakır - Altın - Mat Altın - FÜME		



KOD	ÜRÜN AÇIKLAMASI	ADET
3208	Wing Kulp 160 mm - 224 mm	50
Siyah - Krom - Antik Sarı - Antik Bakır - Altın - Mat Altın - Füme		



KOD	ÜRÜN AÇIKLAMASI	ADET
3209	Yat Kulp 160 mm - 224 mm	50
Siyah - Krom - Antik Sarı - Antik Bakır - Altın - Mat Altın - FÜME		



KOD	ÜRÜN AÇIKLAMASI	ADET
3212	Polygon Kulp 160 mm - 224 mm	50
Siyah - Krom - Antik Sarı - Antik Bakır - Altın - Mat Altın - Füme		



KOD	ÜRÜN AÇIKLAMASI	ADET
3213	Roof Kulp 160 mm - 224 mm	50
Siyah - Krom - Antik Sarı - Antik Bakır - Altın - Mat Altın - FÜME		

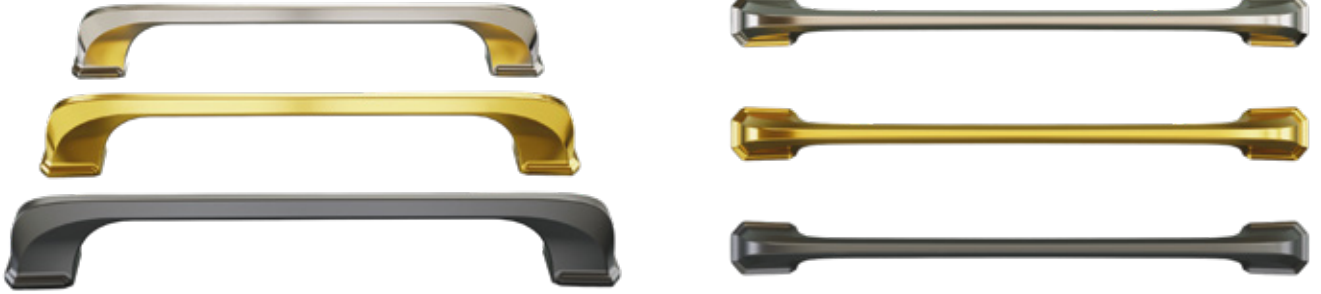

KOD	ÜRÜN AÇIKLAMASI	ADET
3218	King Kulp 160 mm - 224 mm	50
Siyah - Krom - Antik Sarı - Antik Bakır - Altın - Mat Altın - Füme		



KOD	ÜRÜN AÇIKLAMASI	ADET
3205	Diverse Kulp 160 mm - 224 mm	50
Siyah - Krom - Antik Sarı - Antik Bakır - Altın - Mat Altın - Füme		

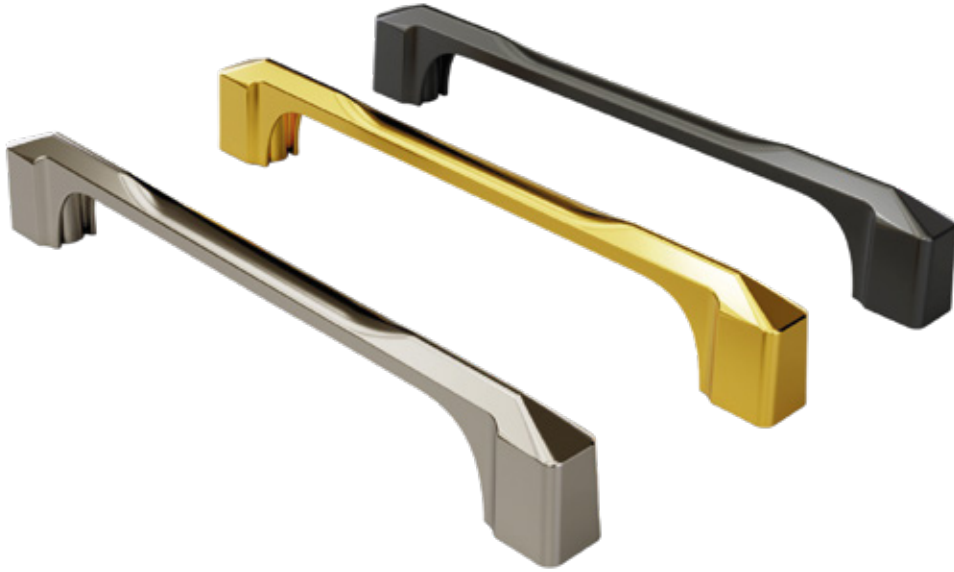
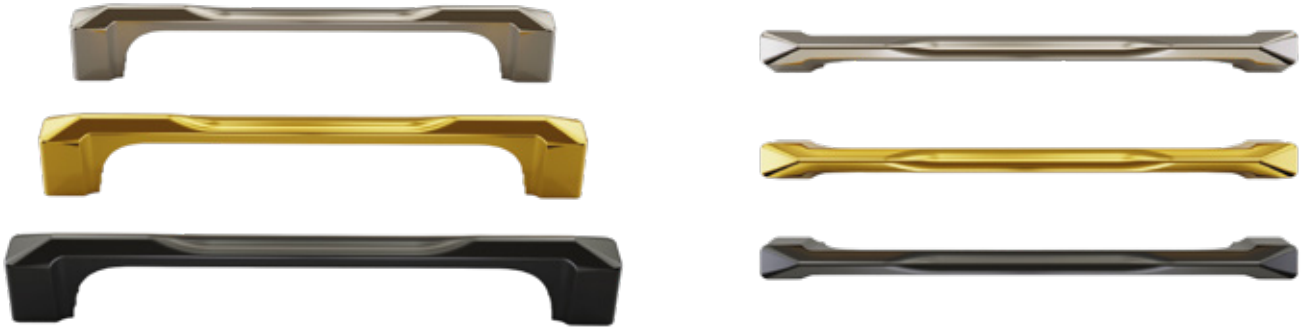

KOD	ÜRÜN AÇIKLAMASI	ADET
3202	Piramit Kulp 160 mm - 224 mm	50
Siyah - Krom - Antik Sarı - Antik Bakır - Altın - Mat Altın - Füme		

KOD	ÜRÜN AÇIKLAMASI	ADET
ET-06655	Mert Düğme	50
Siyah - Krom - Antik Sarı - Antik Bakır - Altın - Mat Altın - Füme		



KOD	ÜRÜN AÇIKLAMASI	ADET
3120	Yuvarlak Düğme	150
Siyah - Krom - Antik Sarı - Antik Bakır - Altın - Mat Altın - Füme		



KOD	ÜRÜN AÇIKLAMASI	ADET
3108	Kare Düğme	150
Siyah - Krom - Antik Sarı - Antik Bakır - Altın - Mat Altın - Füme		



KOD	ÜRÜN AÇIKLAMASI	ADET
ET-06673	Seçil Düğme	100
Siyah - Krom - Antik Sarı - Antik Bakır - Altın - Mat Altın - Füme		





KOD	ÜRÜN AÇIKLAMASI	ADET
V3029	Yuvarlak Halka	150
Siyah - Krom - Antik Sarı - Antik Bakır - Altın		



KOD	ÜRÜN AÇIKLAMASI	ADET
BK-1017	Üçgen Halka	150
Siyah - Krom - Antik Sarı - Antik Bakır - Altın		



KOD	ÜRÜN AÇIKLAMASI	ADET
V3037	Tuana Portmanto	50
V3110	Tuana Askı	50
Siyah - Krom - Altın		



KOD	ÜRÜN AÇIKLAMASI	ADET
V3036	Nur Portmantot	50
V3109	Nur Askı	50
Siyah - Krom - Antik Sarı - Antik Bakır - Altın - Mat Altın - Füme		



KOD	ÜRÜN AÇIKLAMASI	ADET
V3023	Yıldız Portmanto	50
V3106	Yıldız Askı	50
Siyah - Krom - Antik Sarı - Antik Bakır - Altın - Mat Altın - Füme		



KOD	ÜRÜN AÇIKLAMASI	ADET
V3038	Troy Portmanto	50
V3038	Troy Askı	50
Siyah - Krom - Altın		

KOD	ÜRÜN AÇIKLAMASI	ADET
V3103	Mali Portmanto	50
V3021	Mali Askı	50
Siyah - Krom - Altın		



KOD	ÜRÜN AÇIKLAMASI	ADET
ET-04934	Kristal Portmanto	50
ET-04935	Kristal Askı	50
Siyah - Krom - Altın		



KOD	ÜRÜN AÇIKLAMASI	ADET
V3020	Noktalı Portmanto	50
V3101	Noktalı Askı	50
Siyah - Krom - Altın		





Since
1983



info@egetamas.com.tr
www.egetamas.com.tr



Kemalpaşa Mahallesi 7405/2
Sokak No:6 Pınarbaşı İZMİR



+90 232 478 45 40
+90 232 478 30 20

